



Add: No.5, SiqianRd., Xinguang Industry Zone, Liushi Town,
Yueqing, Zhejiang, China

Tel: +86-577-6273 6728

E-mail: info@chinalockout.com

Website: www.chinalockout.com



PROFESSIONAL SAFETY LOCKOUT SUPPLIER

PRODUCT CATALOG

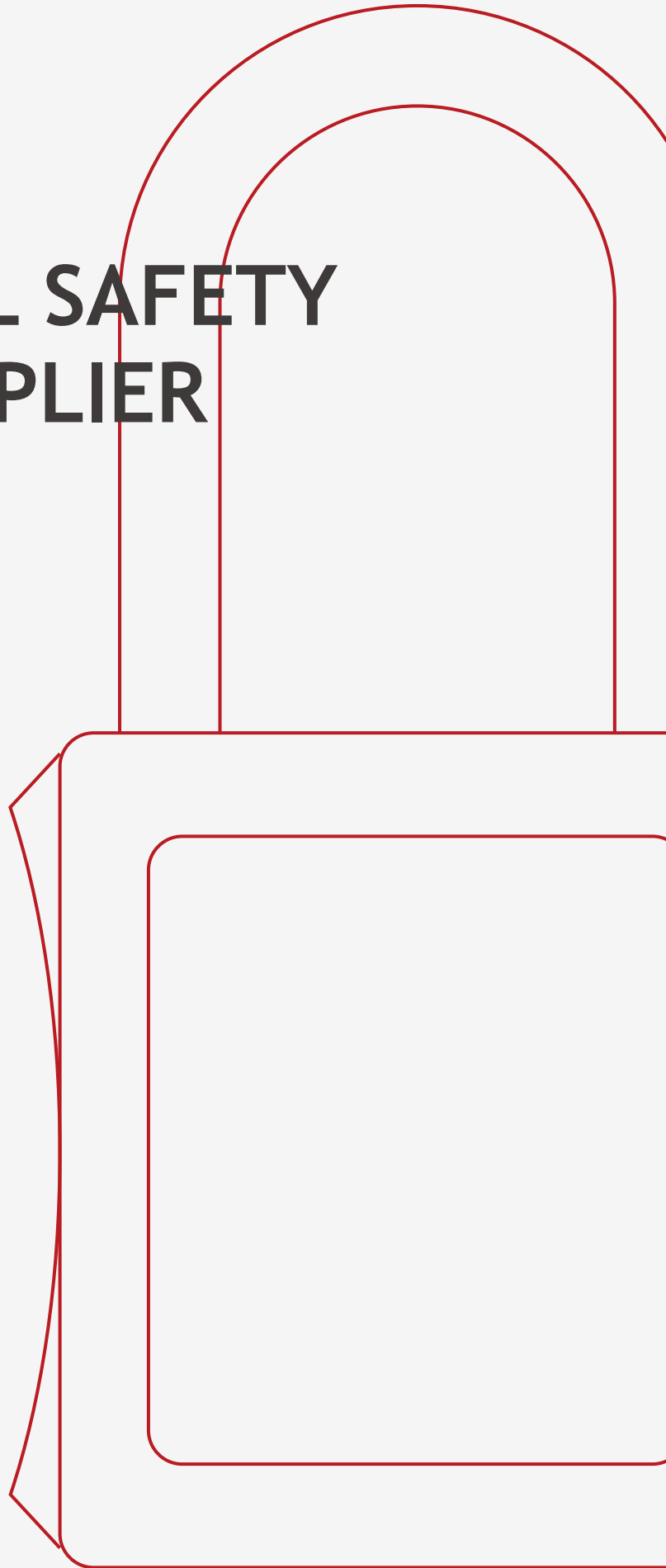

About us

Elecpopular Safety Products Co., Ltd is a leading provider of lockout tagout solutions, with over a decade of expertise in the field. Committed to the ethos of hazard prevention through LOTO measures, we specialize in producing high-quality safety padlocks, lockout hasps, valve lockouts, electrical lockouts, lockout kits, and stations. Additionally, we are fully equipped to offer tailor-made OEM and ODM services for bespoke designs. Choose Elecpopular for top-notch safety products and personalized service.

GLOBAL MARKETING



MAJOR CERTIFICATES



APPLICATION SCENE

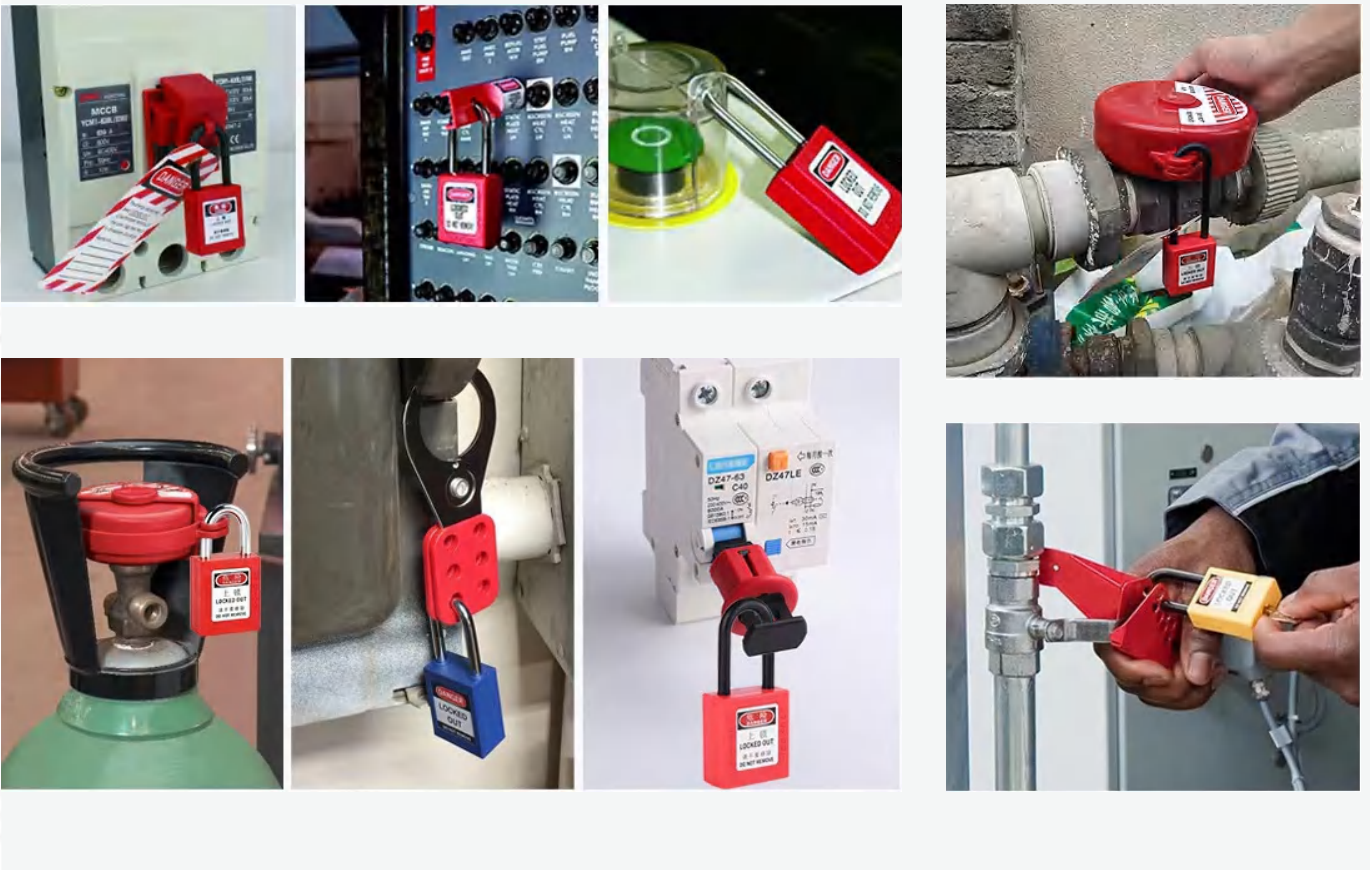

KEYS MANAGEMENT SYSTEM

Padlocks Keyed to Differ:Each padlock is keyed differently,one key included with each lock.

Padlocks Keyed Alike:In one team,each padlock is keyed the same,one key or several keys will open all padlocks.

You can order different teams,and different team padlocks can not be opened mutually by the different individual keys.

Padlocks Master&Differ:Each padlock is keyed differently,but a master key will override and open any of these padlocks.

You can order different teams,different team padlocks can not be opened mutually.But a master key can open all padlocks.

Padlocks Master&Alike:Make different teams of padlocks keyed alike,and if you want to open all locks,just have a master key,which will override and open any of these padlocks.

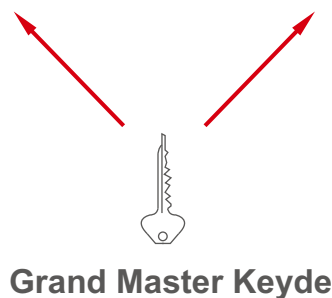
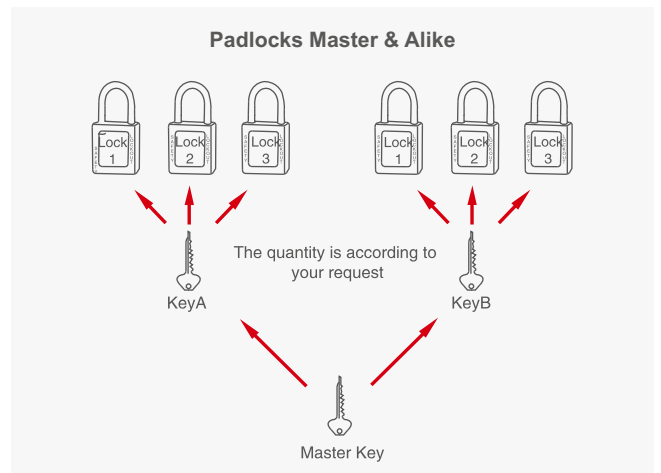
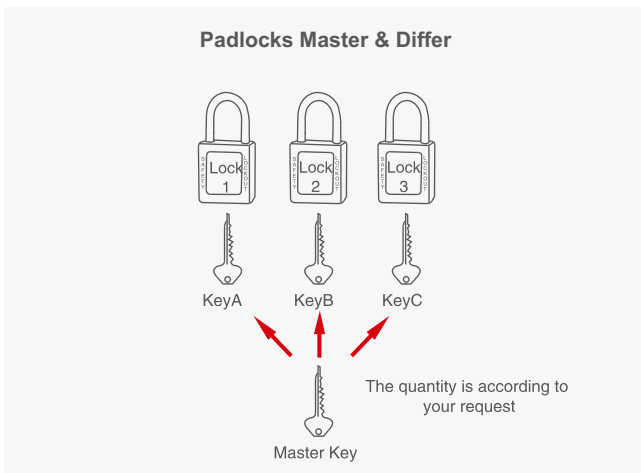
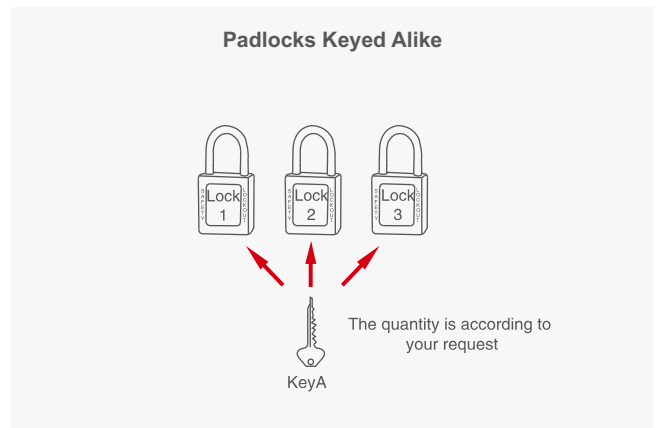
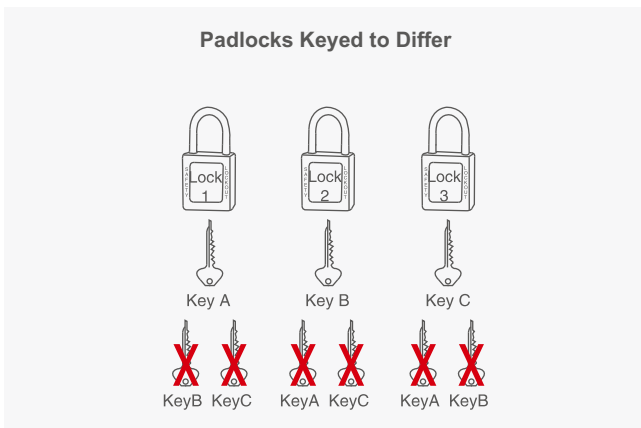

CATALOG

PADLOCKS AND PADLOCK LABELS

01-06



CABLE LOCKOUTS

34-39



LOCKOUT HASPS

07-11



Pneumatic Lockouts

40-42



ELECTRICAL EQUIPMENT LOCKOUTS

12-27



LOCKOUT TAGOUT STATIONS AND LOCKOUT TAGOUT KITS

43-59



VALVE LOCKOUTS AND HOSE LOCKOUTS

28-33



LOCKOUT TAGS

60-65



PADLOCKS AND PADLOCK LABELS

Lockout tagout and padlock labels allow you to quickly identify equipment, areas and padlocks with important lockout/tagout (LOTO) information. These are self-adhering high-performance labels that can withstand harsh environments. Lockout tagout and padlock labels improve worker awareness, preventing unauthorized access and unexpected machine start ups.



OEM SERVICE SUPPORTED

other languages and designs

Number engraving on key



DANGER LOCKED OUT DO NOT REMOVE	PROPERTY OF: _____ _____ _____
PELIGRO EQUIPO BLOQUEADO NO RETIRAR	PROPIEDAD DE: _____ _____ _____
DANGER VERROUILLÉ NE PAS ENLEVER	PROPRIÉTÉ DE: _____ _____ _____
ACHTUNG AUSGESCHLOSSEN NICHT ENTFERNEN	EIGENTUM VON: _____ _____ _____
NEBEZPIECZNIŃSTWO ZABLOKOWANE NIE USUWAC	WŁASNOŚĆ: _____ _____ _____

Regular Shackles



38mm steel shackle



76mm steel shackle



38mm stainless steel shackle



Cable shackle



38mm insulation shackle



76mm insulation shackle

Regular lock bodies



A BODY



B BODY



C BODY



LONG BODY



SLIM BODY

SAFETY PADLOCK

38mm Shackle, diameter 6mm

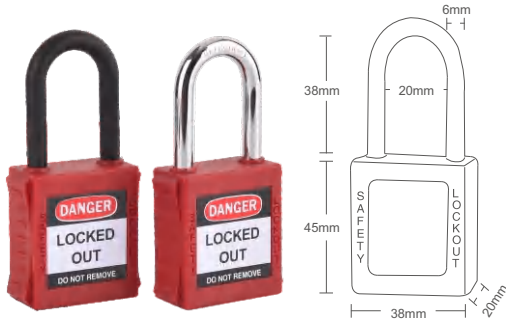

Features:

- Brass cylinder and key
- PA lock body is resistant impact, UV, corrosion, heat and low temperature -20 to 120, Durable, light weight, Non – conductive.
- Key retaining-ensures that padlock is not left unlocked.
- Standard "Danger" label and write on properly labels included front and back.

Other service:

- 1) Laser printing for body and key.
- 2) Can be engraved with customer's Logo and OEM service.

Part No.	Key System	Shackle Material
EP-8521	Keyed to differ	38MM Steel Shackle
EP-8522	Key alike	
EP-8523	Master for Keyed alike	
EP-8524	Master for Keyed to differ	
EP-8521S	Keyed to differ	38MM Stainless Steel
EP-8522S	Key alike	
EP-8523S	Master for Keyed alike	
EP-8524S	Master for Keyed to differ	
EP-8531	Keyed to differ	38MM Insulation Shackle
EP-8532	Key alike	
EP-8533	Master for Keyed alike	
EP-8534	Master for Keyed to differ	
Color	● RED, ● YLW, ● BLU, ● DBL, ● GRN, ● ORG, ● PRP, ● BRN, ● BLK, ○ WHT, ● GRY,	

Features:

- Brass cylinder and key
- PA lock body is resistant impact, UV, corrosion, heat and low temperature -20 to 120, Durable, light weight, Non – conductive.
- Key retaining-ensures that padlock is not left unlocked.
- Standard "Danger" label and write on properly labels included front and back.

Other service:

- 1) Laser printing for body and key.
- 2) Can be engraved with customer's Logo and OEM service.

Part No.	Key System	Shackle Material
EP-8551	Keyed to differ	76mm Steel shackle
EP-8552	Key alike	
EP-8553	Master for Keyed alike	
EP-8554	Master for Keyed to differ	
EP-8551L	Keyed to differ	76mm Insulation shackle
EP-8552L	Key alike	
EP-8553L	Master for Keyed alike	
EP-8554L	Master for Keyed to differ	
Color	● RED, ● YLW, ● BLU, ● DBL, ● GRN, ● ORG, ● PRP, ● BRN, ● BLK, ○ WHT, ● GRY,	

LONG SAFETY PADLOCK

76mm shackle, diameter 6mm



CABLE PADLOCK

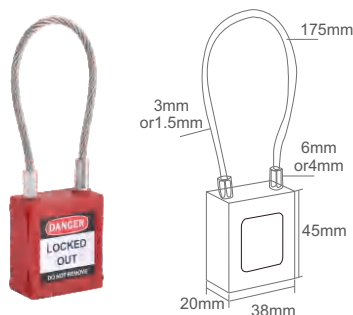

Features:

- Brass cylinder and key
- PA lock body is resistant impact, UV, corrosion, heat and low temperature -20 to 120, Durable, light weight, Non – conductive.
- Key retaining-ensures that padlock is not left unlocked.
- Standard "Danger" label and write on properly labels included front and back.

Other service:

- 1) Laser printing for body and key.
- 2) Can be engraved with customer's Logo and OEM service.

Part No.	Key System	Shackle Material
EP-8541	Keyed to differ	Cable length 175mm, Cable dia: 3.0mm
EP-8542	Key alike	
EP-8543	Master for Keyed alike	
EP-8544	Master for Keyed to differ	
EP-8541T	Keyed to differ	Cable length 175mm, Cable dia: 1.5mm
EP-8542T	Key alike	
EP-8543T	Master for Keyed alike	
EP-8544T	Master for Keyed to differ	
Color	● RED, ● YLW, ● BLU, ● DBL, ● GRN, ● ORG, ● PRP, ● BRN, ● BLK, ○ WHT, ● GRY,	

SLIM BODY SAFETY PADLOCK

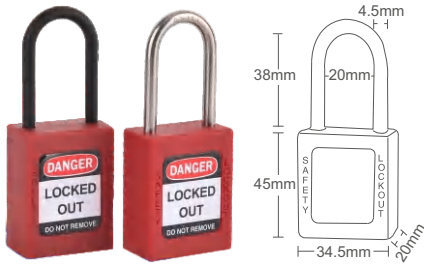

Features:

- Brass cylinder and key
- PA lock body is resistant impact, UV, corrosion, heat and low temperature -20 to 120, Durable, light weight, Non – conductive.
- Key retaining-ensures that padlock is not left unlocked.
- Standard "Danger" label and write on properly labels included front and back.

Other service:

- 1) Laser printing for body and key.
- 2) Can be engraved with customer's Logo and OEM service.

Part No.	Key System	Shackle Material
EP-8521N	Keyed to differ	Slim 316 Stainless Steel
EP-8522N	Key alike	
EP-8523N	Master for Keyed alike	
EP-8524N	Master for Keyed to differ	
EP-8531N	Keyed to differ	Slim insulation
EP-8532N	Key alike	
EP-8533N	Master for Keyed alike	
EP-8534N	Master for Keyed to differ	
Color	● RED, ● YLW, ● BLU, ● DBL, ● GRN, ● ORG, ● PRP, ● BRN, ● BLK, ○ WHT, ● GRY,	

Features:

- Brass cylinder and key
- PA lock body is resistant impact, UV, corrosion, heat and low temperature -20 to 120, Durable, light weight, Non – conductive.
- Key retaining-ensures that padlock is not left unlocked.
- Standard "Danger" label and write on properly labels included front and back.

Other service:

- 1) Laser printing for body and key.
- 2) Can be engraved with customer's Logo and OEM service.

Part No.	Key System	Shackle Material
EP-8571	Keyed to differ	38MM Steel Shackle
EP-8572	Key alike	
EP-8573	Master for Keyed alike	
EP-8574	Master for Keyed to differ	
EP-8581	Keyed to differ	38MM Insulation Shackle
EP-8582	Key alike	
EP-8583	Master for Keyed alike	
EP-8584	Master for Keyed to differ	
Color	● RED, ● YLW, ● BLU, ● DBL, ● GRN, ● ORG, ● PRP, ● BRN, ● BLK, ○ WHT, ● GRY,	

LONG BODY SAFETY PADLOCK



ALUMINUM BODY COATED PLASTIC SAFETY PADLOCK

Features:

- Brass cylinder and key
- Aluminum coated plastic
- Key retaining-ensures that padlock is not left unlocked.
- Standard "Danger" label and write on properly labels included front and back.

Other service:

- 1) Laser printing for body and key.
- 2) Can be engraved with customer's Logo and OEM service.



Part No.	Key System	Shackle Material
EP-8521AP	Keyed to differ	38MM Steel coated Rubber shackle
EP-8522AP	Key alike	
EP-8523AP	Master for Keyed alike	
EP-8524AP	Master for Keyed to differ	
EP-8551AP	Keyed to differ	76MM Steel coated Rubber shackle
EP-8552AP	Key alike	
EP-8553AP	Master for Keyed alike	
EP-8554AP	Master for Keyed to differ	
Color	● RED, ● YLW, ● BLU, ● DBL, ● GRN, ● ORG, ● PRP, ● BRN, ● BLK, ○ WHT, ● GRY,	

ALUMINUM PADLOCK

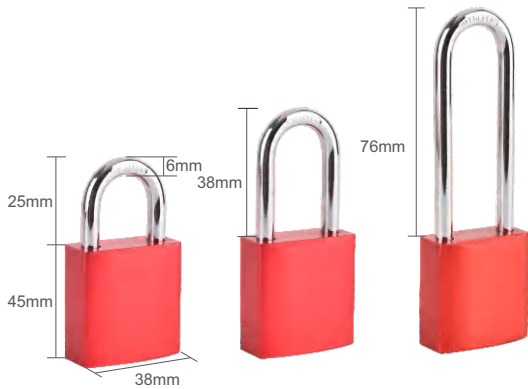

Features:

- Brass cylinder and key
- Body: Aluminum
- Key retaining-ensures that padlock is not left unlocked.
- Standard "Danger" label and write on properly labels included front and back.

Other service:

- 1) Laser printing for body and key.
- 2) Can be engraved with customer's Logo and OEM service.

Part No.	Key System	Shackle Material
EP-8511A	Keyed to differ	25MM Steel Shackle
EP-8512A	Key alike	
EP-8513A	Master for Keyed alike	
EP-8514A	Master for Keyed to differ	38MM Steel Shackle
EP-8521A	Keyed to differ	
EP-8522A	Key alike	
EP-8523A	Master for Keyed alike	76MM Steel Shackle
EP-8524A	Master for Keyed to differ	
EP-8551A	Keyed to differ	
EP-8552A	Key alike	76MM Steel Shackle
EP-8553A	Master for Keyed alike	
EP-8554A	Master for Keyed to differ	
Color	● RED, ● YLW, ● BLU, ● DBL, ● GRN, ● ORG, ● PRP, ● BRN, ● BLK, ○ WHT, ● GRY,	

Features:

- Reinforced laminated steel withstands sever physical abuse while hardened steel shackle resists tampering
- Body plates individually coated for superior rust protection
- 5-pin cylinder offers more unique key cuts for better tamper resistance

Other service:

- 1) Laser printing for body and key.
- 2) Can be engraved with customer's Logo and OEM service.

Part No.	Key System	Shackle Material
EP-8561	KA, KD, MK	19MM Steel Shackle
EP-8562	KA, KD, MK	38MM Steel Shackle
EP-8563	KA, KD, MK	51MM Steel Shackle
Color	● RED, ● YLW, ● BLU, ● DBL, ● GRN, ● ORG, ● PRP, ● BRN, ● BLK, ○ WHT, ● GRY,	

Laminated steel padlocks



DUST-PROOF COVER OF SAFETY PADLOCK

- Dust-proof cover made from silica gel ,specially customize for unique padlock body
- Dust-proof cover suitable for dusty working space
- Protect key hole from entering dust



EP-CA



EP-CB

Part Code	Description	Cover material	Specification
EP-CA	Black dustproof cover	Dust-proof silica gel	Specially customize for unique padlock body; Advantage: integrated removable, soft silica gel to protect padlock body,excellent dust-proof function

Part Code	Description	Cover material	Specification
EP-CB	Translucent dustproof cover	Dust-proof silica gel	Specially customize for unique padlock body; Advantage: integrated removable, soft silica gel to protect padlock body,excellent dust-proof function

PORTABLE PADLOCK LOCKOUT



- Made from engineering plastic reinforced nylon injection molding.
- Labels available.
- Can carry up to 12 padlocks at the same time.

Part Code	Description
EP-B41	Can be customized

- Made from carbon steel material.
- This range of padlock stations are ideal equipment to allow easy access to place padlocks when needed. Supplied with 5 padlocks, 10 padlocks, 15 padlocks and 20 padlocks.

PADLOCK STATION



Part Code	Description
EP-B31	Length 140mm×width 40mm×height 80mm, can accommodate 5 padlocks
EP-B32	Length 270mm×width 40mm×height 80mm, can accommodate 10 padlocks
EP-B33	Length 400mm×width 40mm×height 80mm, can accommodate 15 padlocks
EP-B34	Length 530mm×width 40mm×height 80mm, can accommodate 20 padlocks

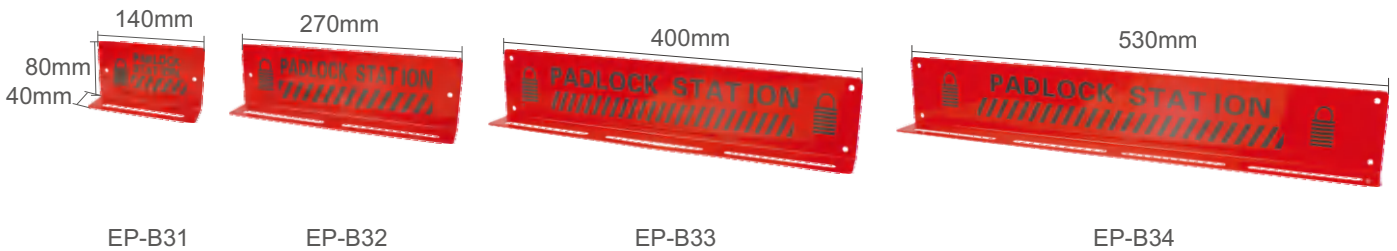

Key Cover



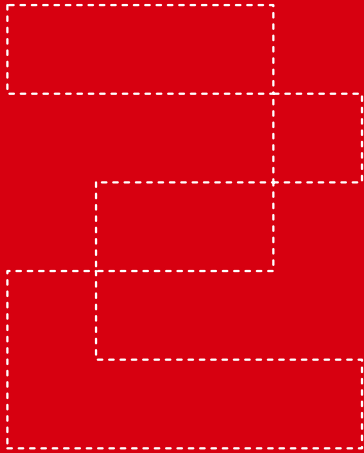

LOCKOUT HASPS

Lockout hasps are a valuable and convenient way to lockout an energy source ensuring that your worker's safety is never compromised. Our hasps are available in a variety of highly visible, labeled and nonconductive options. They are ideal for group lockout procedures and will help give your team the piece of mind that each energy source is properly isolated.



STEEL HASP LOCKOUT

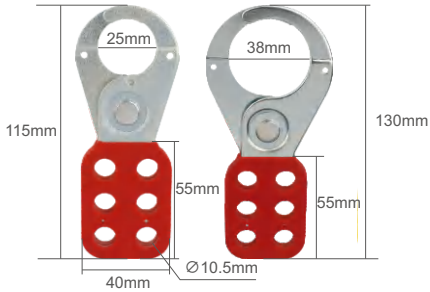

- Lockout by multiple workers at each lockout point
- Attach device to energy disconnect switch
- Keeps equipment inoperative while repairs or adjustments are made
- Control cannot be turned on until last worker's padlock is removed from hasp
- Heavy duty pry proof steel jaw with vinyl coated handle

Part No.	DESCRIPTION
EP-8311 1"	Steel hook with plastic coated body, 115mm lenth*45mm width, hook size is 25mm
EP-8312 1.5"	Steel hook with plastic coated body, 130mm lenth*60mm width, hook size is 38mm

- Steel lockout hasp includes tamperproof interlocking tabs to prevent unauthorized opening. Constructed of case-hardened steel with rust proof plating and bright red nylon.

Part No.	DESCRIPTION
EP-8316 1"	Steel hook with plastic coated body, 115mm lenth*45mm width, hook size is 25mm
EP-8317 1.5"	Steel hook with plastic coated body, 130mm lenth*60mm width, hook size is 38mm

STEEL LOCKOUT HASP WITH TAB

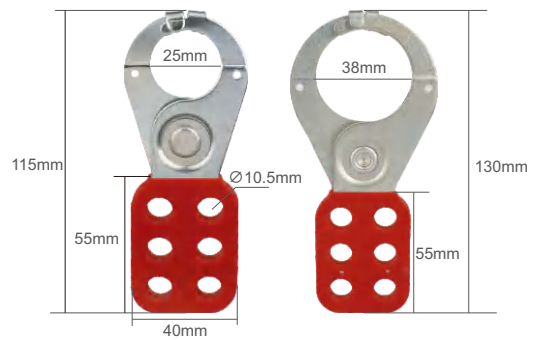

- Lockout by multiple workers at each lockout point
- Attach device to energy disconnect switch
- Keeps equipment noperative while repairs or adjustments are made
- Control cannot by turned on unti! last worker's padlock is removed from hasp
- Heavy duty pry proof steel jaw with vinyl coated handle

Part No.	DESCRIPTION
EP-8326 1"	steel hook with plastic coated body, 193mm length*45mm width, hook size is 25mm
EP-8327 1.5"	steel hook with plastic coated body, 193mm length*60mm width, hook size is 38mm

STEEL HASP LOCKOUT



- Lockout by multiple workers at each lockout point
- Attach device to energy disconnect switch
- Keeps equipement noperative while repairs or adjustments are made
- Control cannot by turned on unti! last worker's padlock is removed from hasp
- Heavy duty pry proof steel jaw with vinyl coated handle

Part No.	DESCRIPTION
EP-8328 1"	steel hook with plastic coated body, 193mm length*45mm width, hook size is 25mm
EP-8329 1.5"	steel hook with plastic coated body, 193mm length*45mm width, hook size is 25mm

STEEL HASP LOCKOUT WITH TAB



ALUMINUM HASP

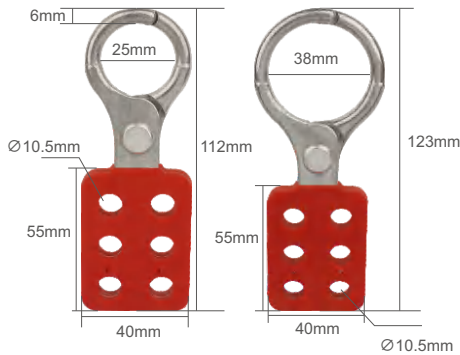

- Made from Aluminum with engineering plastic nylon PA injection molding.
- Lock hole diameter 10.5mm (2/5")
- Lock shackle diameter: 25mm and 38mm

Part No.	DESCRIPTION
EP-8314	Lock shackle 1" (25mm)
EP-8315"	Lock shackle 1.5" (38mm)

- Made from steel materials, high temperature spray plastics and rust treatment.
- Lock hole diameter: 10.5mm (2/5")
- Lock shackle diameter: 25mm (1") & 38mm (1.5")

Part No.	DESCRIPTION
EP-8311P	Lock shackle 25mm (1"), 115mm lenthx40mm width
EP-8312P	Lock shackle 38mm (1.5"), 128mm lenthx40mm width

STEEL LOCKOUT HASP

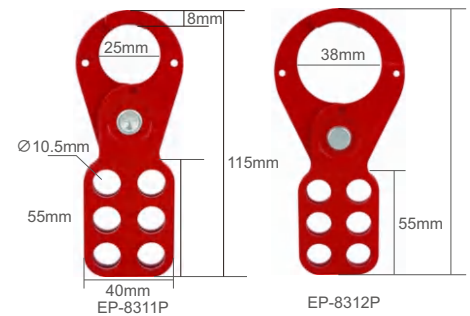

STEEL LOCKOUT HASP WITH HOOK

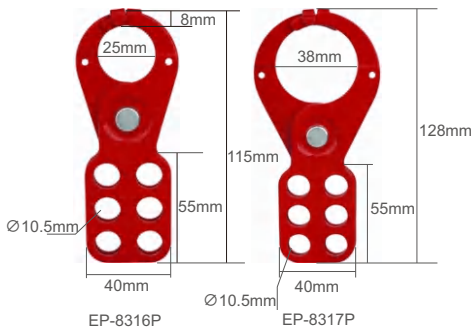

- Made from steel materials, high temperature spray plastics and rust treatment.
- Lock hole diameter: 10.5mm (2/5")
- Lock shackle diameter: 25mm (1") & 38mm (1.5")
- Hooks are provided to avoid self-opening of the hasps.

Part No.	DESCRIPTION
EP-8316P	Lock shackle 25mm (1"), 115mm lenthx40mm width
EP-8317P	Lock shackle 38mm (1.5"), 128mm lenthx40mm width

- Made from high strength steel lock body, High temperature spray plastics surface rust treatment on the surface
- Double function design, two kinds of lock hook in the two ends.

Part No.	DESCRIPTION
EP-8320	Allow to 6 padlocks, Hook Dia: Head dia: 44.5mm ; Tail dia: 18.5mm

DOUBLE-END STEEL HASP



ALUMINUM LOCKOUT HASP



- Made from super aluminum alloy
- The traditional hasp and tag integration become one.
- Write-on labels surface accepts pencil, pen or marker, repeated uses allowed
- All colors are available

Part No.	Size	Hole Dia	Qty for padlock
EP-8321	18cm(H)x 7cm(W)	8.5mm	9pcs
EP-8321N	17.8cm(H)x7.3cm(W)	8mm	5pcs
EP-8322	19cm(H)x 7.7cm(W)	8mm	7pcs
EP-8323	11.6cm(H)x5cm(W)	8.5mm	6pcs

- Made from aluminum alloy
- Lock hole diameter 8mm
- Suitable for multi-person lock management

Part No.	DESCRIPTION
EP-K71	Allow to 12 padlocks
EP-K72	Allow to 24 padlocks

ALUMINUM BUCKLE LOCK

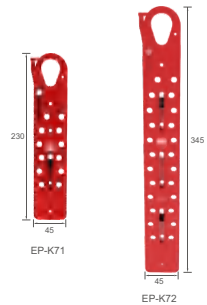

INSULATION HASP LOCKOUT

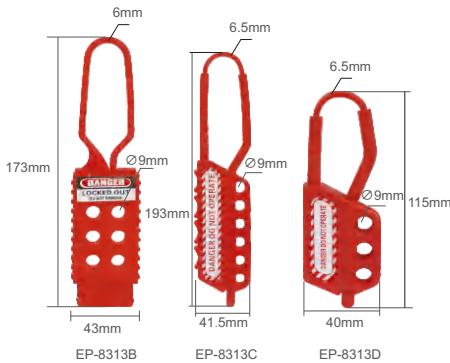

- Body and jaw in spark proof nylon construction,
- with light weight only 28g, but can be withstand 450g
- Flexible scalability better, a lock beam bending 360 degrees without deformation
- Lockout by multiple workers at each lockout point
- Keeps equipment inoperative while repairs or adjustments are made
- Dimensions are 1-5/8" x 6-7/8" (4.1cm x 17.4cm) with 1" x 2-1/2" (2.5cmx6.3cm) inside jaw diameter, holds up to 6•Ideal for electrical isolation

Part No.	Size	Hole Dia	Qty for padlock
EP-8313B	17.3cm(H)x 4.3cm(W)	9.5mm	6pcs
EP-8313C	19.3cm(H)x 4.15cm(W)	9.5mm	6pcs
EP-8313D	11.5cm(H)x 4.0cm(W)	9.5mm	3pcs

- Material : Non-conductive nylon
- The hasp is placed through the isolating point and closed.
- Allow 4-6 authorized persons to place their own padlocks on it.

NEW INSULATION HASP LOCKOUT

Part No.	Description	Qty for padlock
EP-K44	Nylon lockout hasp, thin shackle Dia 3mm, 61mm*107mm	4pcs
EP-K45	Nylon lockout hasp, thick shackle Dia 6mm, 61mm*107mm	4pcs



STEEL HASP WITH RED PLASTIC HANDLE, EP-8318



- This Steel Hasp features a 2-1/4in (50mm) x 3in (71mm) x 1in (25mm) inside jaw diameter and holds up to two padlocks. The 4mm steel hasp fits smaller lockout points.
- 4mm Steel Hasp.
- 4mm steel hasp fits smaller lockout points.
- Steel shackle, plastic body.
- Dimensions are 2-1/4in (50mm) x 3in (71mm) x 1in (25mm) inside jaw diameter.
- Holds up to 2 safety padlocks.
- Accepts Shackle Diameter up to 9/32in (7mm).

- Made from hardened steel, galvanized rustproof surface.
- Hard to pry, sturdy and durable.

BUTTERFLY LOCKOUT HASP

Part No.	DESCRIPTION	BODY SIZE
EP-K31	Allow to 6 padlocks	60mm Width, 87mm Height
EP-K32	Allow to 10 padlocks	40mm Width, 167mm thickness

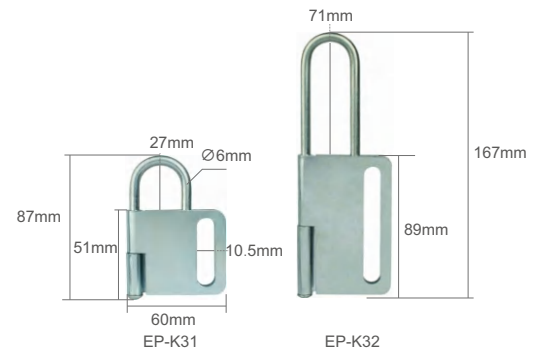

DOUBLE-END ALUMINUM HASP



- Made from high resistance fire resistant aluminum alloy.
- The surface can be plated or high temperature surge anti rust treatment.
- Double ends are different sizes, two functions.

Part No.	DESCRIPTION	Hook Dia. & Head Dia.	Tail Dia.	Color
EP-K61	Allow to 8 padlocks	38mm	25mm	Metallic & Black

ELECTRICAL EQUIPMENT LOCKOUTS

Our electrical lockout products will help you properly shut down electrical systems including: circuit breakers, push-buttons, rotary, wall switches, plugs and much more. These lockout options will help you avoid electrical accidents for industrial high voltage or low voltage applications.

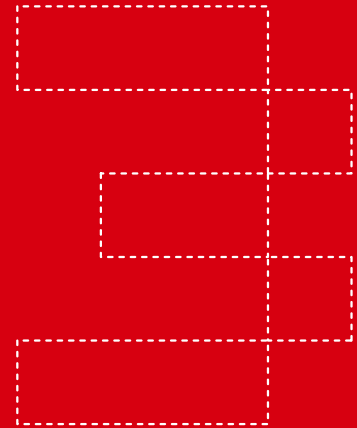

MINIATURE CIRCUIT BREAKER LOCKOUT

Unit:mm

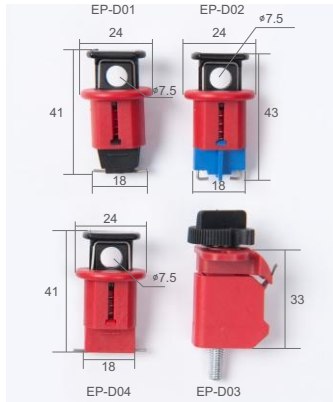

- Material: glass-filled nylon
- Usage: Recommended to use in combination with a padlock for added safety. And can be easily installed with the aid of a push button. The lockouts can take padlocks with a shackle diameter up to 6 mm.
- Features: a) OEM Manufacturing Service Supported
b) no installation tools required.
c) available for single and multi-pole breakers
- Applied: Fit most existing types of European and Asia Circuit Breaker.

MODEL	DESCRIPTION
EP-D01	POS (Pin Out Standard), hole spacing ≤ 12 mm
EP-D02	POS (Pin In Standard), hole spacing ≤ 12 mm
EP-D03	TBLO (Tie Bar Lockout)
EP-D04	POW (Pin Out Wide), hole spacing ≤ 20 mm

- Made from rugged reinforced PA
- Can lock it with screw driver
- Can accommodate one safety padlock with shackle Dia. ≤ 7 mm
- Can lock all kinds of circuit breakers

MODEL	DESCRIPTION
EP-D05-1	Suitable for single pole miniature circuit breakers with handle width ≤ 7.7 mm
EP-D05-2	Suitable for 2 to 4 poles miniature circuit breakers
EP-D05-5	Suitable for large size circuit breakers
EP-D05-6	Suitable for mini size circuit breakers with handle width ≤ 9.3 mm middle size circuit breakers with handle width ≤ 12 mm

SIMPLE CIRCUIT BREAKER LOCKOUT

Unit:mm

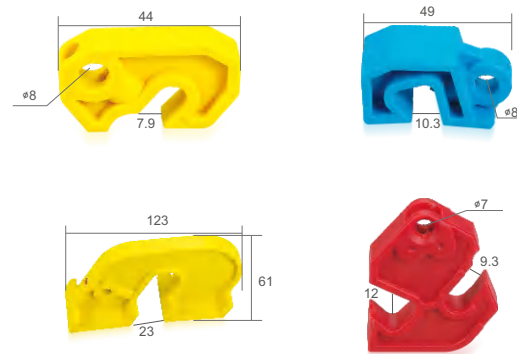

CIRCUIT BREAKER LOCKOUTS

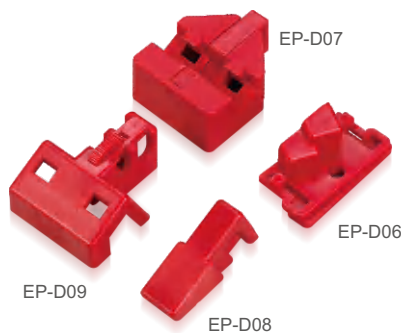

Our range of circuit breaker lockouts are now available for either single or double pole circuit breakers. Manufactured from rigid plastic this range of circuit breaker lockouts allow breakers to be locked off individually.

MODEL	DESCRIPTION
EP-D06	A single pole lockout, requires a switch breaker with a recessed hole in it.
EP-D07	A double pole lockout, requires the breakers to be connected with a cross bar.
EP-D08	A single pole lockout, does not require a switch breaker with a recessed hole in it.
EP-D09	A double pole lockout, similar to EP-D06, but slightly larger to accommodate

CLAMP-ON BREAKER LOCKOUT



MATERIAL: rugged polypropylene and impact modified nylon

DESCRIPTION:

- Use thumbscrew to clamp lockout securely onto switch tongue, then pull over and lock in place to prevent clamp from being loosened.
- New blade design provides tighter grip with less torque on thumb screw.
- Detachable cleats expand the range of applicable breakers.
- The lockout can take padlocks with a shackle diameter up to 7mm.

MODEL	DESCRIPTION
EP-D11	Can lock handle width ≤18mm
EP-D11N	
EP-D12	Can lock handle width ≤42mm
EP-D12N	
EP-D13	Can lock handle width ≤72mm
EP-D13N	

- Made from engineer plastic strengthened nylon PA and chrome plated brass screw.
- With locking screw, no need other tools to look.
- Widely used: applicable to all kinds of small and medium size MCCB, and any miniature circuit breaker.
- Can be customized stainless steel brand.

MODEL	DESCRIPTION	SIZE
EP-D14	Suitable for all kinds of small and medium sized moulded case circuit breakers and any mini circuitbreakers	41mm*14mm*38mm

MULTI-FUNCTION MINIATURE BREAKER LOCKOUT

Unit:mm

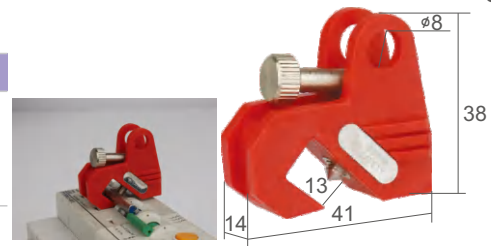

MULTI-FUNCTION MINIATURE BREAKER LOCKOUT

Unit:mm

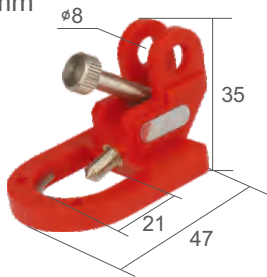

EP-D15



EP-D15W

- Made from rugged reinforced nylon and chrome plated brass screw.
- Comes with locking screw, can lock conveniently by itself without tools.
- Widely used: suitable for middle size circuit breaker(handle width ≤20mm).
- Unique U shape stainless steel insert plate, can ensure there is no swing after lock.
- Can be customized stainless steel brand.

MODEL	DESCRIPTION
EP-D15	Can accommodate one safety padlock with shackle diameter≤7mm
EP-D15W	"W" means there is no pedal under the lock bottom, can accommodate one safety padlock with shackle diameter ≤7mm

- Made from engineer plastic strengthened nylon PA and chrome plated brass screw.
- With locking screw, no need other tools to look. The unique design of the U stain sheet makes it more firm.
- Widely used: for a large variety of MCCB(handle thickness ≤20mm) and special bottom type of circuit breaker,EP-D16L is suitable for few closed old long MCCB.
- Can be customized stainless steel brand.

MODEL	DESCRIPTION
EP-D16	Locked with 1 padlock, lock shackle≤7mm
EP-D16L	With "L" can be locked closing old longer MCCB Locked with 1 padlock, lock shackle ≤7mm

LARGE TYPE CIRCUIT BREAKER LOCKOUT

Unit:mm

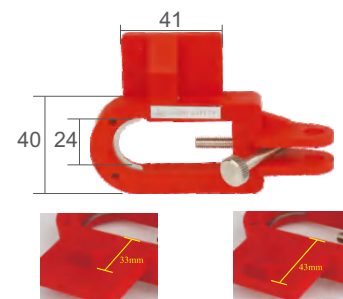

EP-D16

EP-D16L

NEW ARRIVAL CIRCUIT BREAKER LOCKOUT

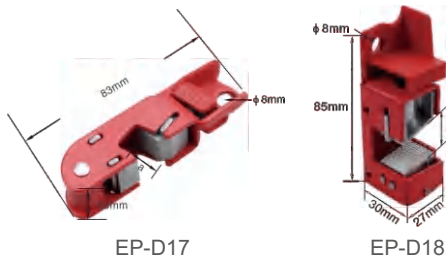

- Material: Die-casting aluminum alloy & Nylon ABS & metal spray.
- Multifunctional small circuit breaker by durable nylon lock screw and copper plating chromium, bring their own lock screw, do not need to tool can conveniently locked.
- Suitable for all kinds of small and medium size molded case circuit breaker, and any miniature circuit breaker.

MODEL	DESCRIPTION
EP-D17	7.5mm≤handle width≤12mm Small and medium circuit breaker
EP-D18	8mm≤handle width≤16mm Small and medium circuit breaker

- Made from Steel .
- Suitable for Schneider NSX accessory locking equipment Molded case circuit breakers.
- Several person management and usage.

MODEL	DESCRIPTION
EP-D19	Suitable for Schneider special circuit breaker

PIN OUT SCHNEIDER MINIATURE BREAKER LOCKOUT

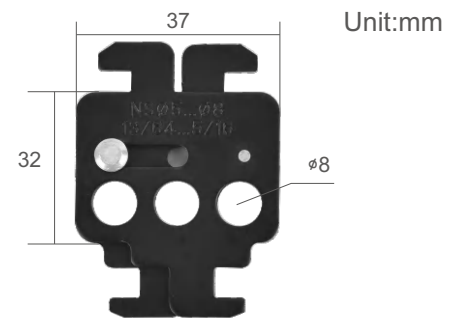

- The lock body is made of nylon;
- With locking screw, no tools can be easily locked.

MODEL	DESCRIPTION
EP-D20	7mm≤handle width≤15mm Small circuit breaker

CIRCUIT BREAKER LOCKOUT TYPE

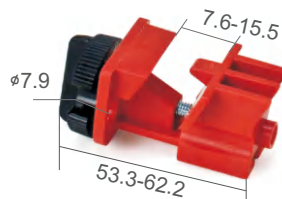

- Material: Aluminum
- Usage: Recommended to use in combination with a padlock for added safety. And can be easily installed. The lockouts can take padlocks with a shackle diameter up to 7 mm.
- Features: available for single and multi-pole breakers
- Applied: Fit most existing types of European and Asia Circuit Breaker.
- Package: 100 pcs/box

MODEL	DESCRIPTION
EP-D26	Suitable for mini circuit breaker



ALUMINUM MINI CIRCUIT BREAKER LOCKOUT DEVICE

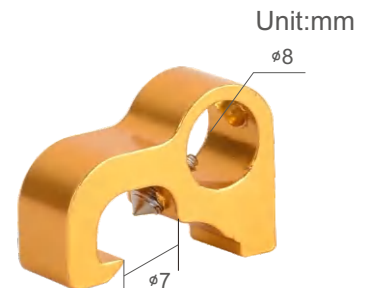

4PIN OUT MINIATURE BREAKER LOCKOUT

Unit:mm



- The body is made from PBT.
- For locking small size circuit breaker.
- The lockouts can take padlock with a shackle diameter up to 8mm.
- Color: yellow, can be customized.

MODEL	DESCRIPTION
EP-D27	suitable for small sized circuit breaker

- The body is made from PA66+ABS.
- For locking Schneider special circuit breaker.
- The lockouts can take padlock with a shackle diameter up to 6mm.
- Color: yellow, can be customized.

MODEL	DESCRIPTION
EP-D28	suitable for Schneider special circuit breaker

PIN OUT SCHNEIDER MINIATURE BREAKER LOCKOUT

Unit:mm

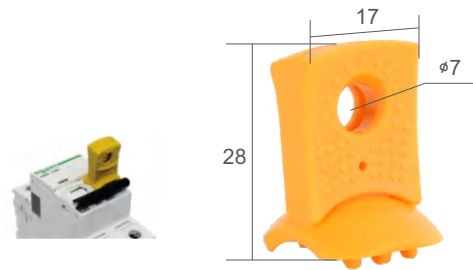

- The body is made from PBT.
- For locking small size circuit breaker.
- The lockouts can take padlock with a shackle diameter up to 8mm.
- Color: yellow, can be customized.

MODEL	DESCRIPTION
EP-D30	Mould-case circuit breaker, Minimum size of opening position ≥ 19mm



CIRCUIT BREAKER LOCKOUT TYPE

Unit:mm

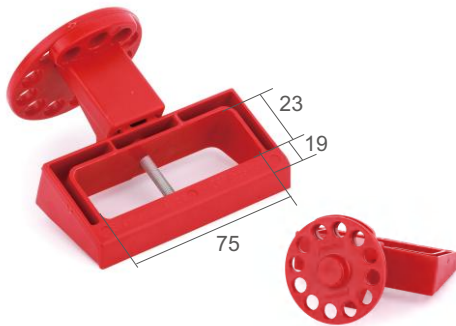

- The body is made from PBT.
- For locking small size circuit breaker.
- The lockouts can take padlock with a shackle diameter up to 8mm.
- Color: yellow, can be customized.

- Made from strong and durable strengthened nylon.
- Keyhole diameter < 8.6mm.
- Suitable for medium and miniature breaker.

MODEL	DESCRIPTION
EP-D100	A:46mm abc:96mm*29.5mm*35mm
EP-D110	A:45mm abc:96mm*29.5mm*35mm



CIRCUIT BREAKER LOCKOUT

Unit:mm



EP-D100

EP-D110

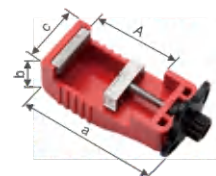

UNIVERSAL MINI CIRCUIT BREAKER LOCKOUT

Unit:mm

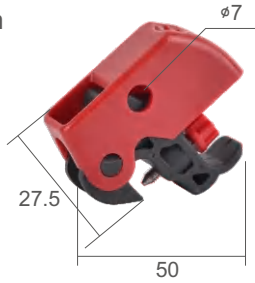

- Can lock out one or multiple connections mini circuit breaker lockout, apply to most switches on the market.
- Material: Nylon and glass fiber
- No need to consider if the circuit breaker has a pinhole, much less the space between two pinholes, can lock out the off position of switch. The manual adjustment for locking is convenient and efficient

MODEL	DESCRIPTION
EP-D2394	handle width ≤ 8 mm Small and medium circuit breaker

- Made of reinforced nylon and transparent high-strengthened glass resin PC.
- Easy to install. Just place the protective cover on the circuit breaker, which can be locked and removed at will. It can be used for various small circuit breakers.
- Can lock 2 safety padlocks with shackle diameter ≤ 7 mm together.

MODEL	DESCRIPTION
EP-D301P	Suitable for various miniature circuit breakers
EP-D302P	
EP-D303P	
EP-D304P	



PROTECTIVE COVER FOR MINIATURE CIRCUIT BREAKER

Unit:mm

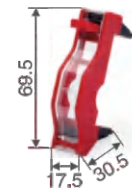

EP-D301P



EP-D302P

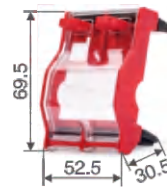

EP-D303P



EP-D304P

480V~600V BREAKER LOCKOUT (BREAK BLOCKER COMPONENTS)

Unit:mm

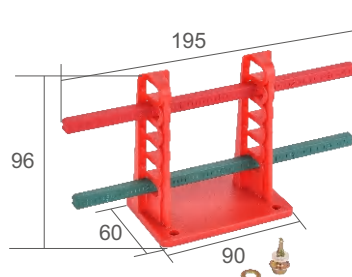
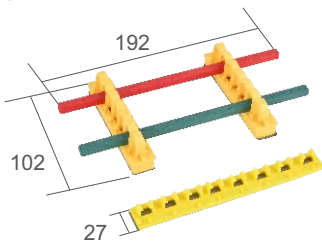

- Made from engineering plastic alloy.
- Back self-adhesive track can fix on the distributor forever—clean the surface of the distributor no hole needed.
- To lock the special large or unique shape switch, the length of the rod is 19cm.
- Red stop rod means the switch is in the off state, green stop rod means the switch is in on state.

MODEL	DESCRIPTION
EP-D22	Can accommodate two safety padlocks with shackle diameter ≤ 7 mm
EP-D22-3	Universal knife gate-main rod length is 195mm



CIRCUIT BREAKER LOCKOUT



- Material - High Quality ABS with metallic screw.
- Plain or normal screw type device can be tighten up with the help of screw driver and foldable screw type device that can be installed directly without the help of any extra tool.
- The device is UV Resistant and it is suitable for single, double, triple and four pole also can be fitted on switches of 30" to 90" height.
- Color - Blue, Red, Yellow, Green ar can make as per quantity required.

MODEL	DESCRIPTION
EP-D14N	A 55mm B 40mm C 26mm D 9mm E 11mm F 19mm

- Material - High Quality ABS with metallic nut.
- Circuit Breaker Lockout with plain and folding screw type that is UV resistant.
- It fits on wide range of switches that is of 0.30" to 0.60" height suitable for single , double, triple and four pole.
- Color - Yellow, Red or any color as per the quantity required.

MODEL	DESCRIPTION
EP-D09N	A 58mm B 35mm C 24.5mm D 10mm E 15mm F 19mm

CIRCUIT BREAKER LOCKOUT

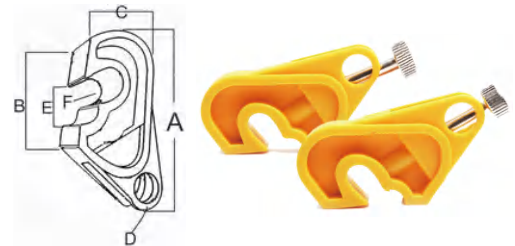

MINIATURE CIRCUIT BREAKER LOCKOUT



- The material of miniature circuit breaker lockout body is ABS, pin 304# stainless steel, excellent weather resistance
- This lockout can control power source effectively by locking miniature circuit breaker whether it's on or off.
- It is more beautiful and more small
- reliable performance and convenient to use

MODEL	DESCRIPTION
EP-E11	locking out the circuit breaker switch space 1-11mm
EP-E12	locking out the circuit breaker switch space of 11mm- 20mm

- Bottom breaker locks with adjustable flap, flap position can be adjusted according to the circuit breaker handle stroke
- Locking relatively wide range, can handle widths up to 23mm to 15mm thickness of the circuit breaker lock. Locking wide range of products to enhance the adaptability
- Lock easy, just hand clockwise rotation of the screw to achieve a fixed design metal teeth of the locking block more reliable
- Linked to keyhole aperture 7.5mm and most secure padlock can be used in conjunction, can also be realized by means of six of the people locked locks

MODEL	DESCRIPTION	Capacity
EP-E21	340(Length)*160(Width)*415mm(height)	Can accommodate 6 padlocks, 12 tags, 6 hasps and, several lockouts etc.
EP-E21A	340(Length)*160(Width)*415mm(height)	Can accommodate 11 padlocks and several lockouts etc.

CIRCUIT BREAKER LOCKOUT



NEW BREAKER LOCKOUT



Locking process is completely manual, without the aid of external tools. Trumpet breaker locks made of ABS plastic with good impact resistance and insulation effect is made, You can lock switch on the air. Effective management and control of energy.

Features:

- Bottom breaker locks with adjustable flap, flap position can be adjusted according to the circuit breaker handle stroke
- Locking relatively wide range, can handle widths up to 23mm to 15mm thickness of the circuit breaker lock. Locking wide range of products to enhance the adaptability
- Lock easy, just hand clockwise rotation of the screw to achieve a fixed design metal teeth of the locking block more reliable
- Linked to keyhole aperture 7.5mm and most secure padlock can be used in conjunction, can also be realized by means of six of the people locked locks

MODEL	DESCRIPTION
EP-E22	breaker handle thickness 4-22mm, width and height and is not limited

Description:

- A lock specially designed and developed for locking circuit breaker switches with arcs.
- The patented structural design enables the bayonet to be fine-tuned within 170 degrees, greatly increasing its blocking stroke, and has powerful universal performance and solves the problem of locking. Solved the problem of arc protrusion in the switch handle groove.
- Scope of application: switch handle thickness $\leq 25\text{mm}$, switch handle width $\geq 10\text{mm}$, handle Height $\geq 13\text{mm}$.
- Made of reinforced nylon and stainless steel, sturdy and durable, lightweight.
- Using one-piece stainless steel teeth, the bayonet strength is higher and the clamping is more stable. It can be locked by up to two people, and the locking hole diameter is 8mm.

Universal circuit breaker lock Product EP-E22A

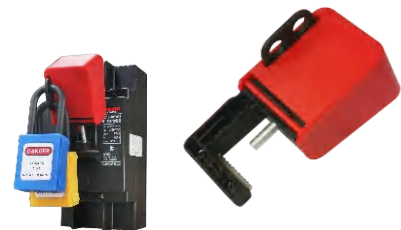

Multifunctional circuit breaker lock

EP-E15A



Description:

It can lock both the small molded case circuit breaker switch and the micro circuit breaker device switch.

Features:

- Strong versatility, it can lock both molded case circuit breaker switches and micro circuit breaker switches close.
- Scope of application: switch handle thickness $\leq 15\text{mm}$, switch handle height $\leq 15\text{mm}$.
- Made of reinforced nylon and stainless steel, sturdy and durable, compact in size, easy to use/portable and bring convenience.
- Comes with stainless steel teeth for more stable clamping.
- Keyhole diameter 8mm.

Description:

Mainly used for locking motor/motor circuit breaker switches

Features:

- Made of reinforced nylon, sturdy and durable
- Metal tooth-shaped clamping design, locking more firmly
- Loose/tighten by hand, fast locking

MODEL	DESCRIPTION
EP-E25	Locking length: 41-57mm, width 25mm, height 22mm
EP-E26	Locking length: 41-57mm, width 38mm, height 22mm

Circuit breaker lockout



EP-E25



EP-E26

CIRCUIT BREAKER LOCKOUT (SMALL)



- Shell is made of ABS resin, and main body is high carbon steel.
- External dimensions: Length 68.5mm, Width 23.5mm, Thickness 14mm.
- With a knob can tighten directly to install, easy to use, without assistant tools.
- Use with professional safety padlock and tag together.

MODEL	DESCRIPTION
EP-8126	Suitbale for the circuit breaker toggle switch thickness < 10mm, no limit for width.

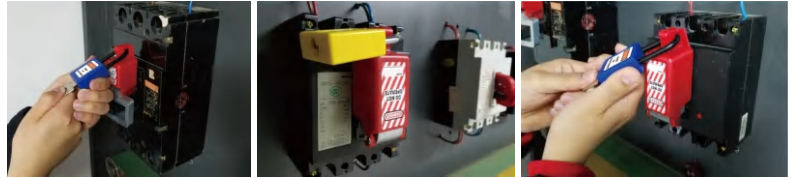

- Shell is made of ABS resin, and main body is high carbon steel.
- With a knob can tighten directly to install, easy to use, without assistant tools.
- Use with professional safety padlock and tag together.

MODEL	DESCRIPTION
EP-8127	Suitbale for all kinds of medium-sized circuit breaker (handle thicknedd≤18mm, no limit to width).

CIRCUIT BREAKER LOCKOUT (BIG)



UNIVERSAL WALL-TYPE SWITCH COVER

Unit:mm



- Made from engineering plastic ABS and acrylic.
- English warning sign on the body is available.
- Can be locked with safety padlock of shackle diameter≤7mm.

MODEL	DESCRIPTION
EP-D23	Suitbale for wall switch base hole size:38*40mm

- Material-ABS base with steel or strong polypropylene strip.Electrical Handle Lockout for electrical panel is made of four parts which is used to block the movement of handles and lever installed at electric panel,is available with or without lock.
- Locking Slot-Two holes or strong adhesive at base part so that it can be stucked solidly within some hour and also can be screwed for tight sticking on oily surface and then locked by the padlock.
- Size of Base-Diameter is 59 mm,thickness 10 mm and size of slotter part is 25mm×18mm×7mm.
- Steel/Plastic grip with edge to edge length is 435mm,width 19mm,with multiple holes of 9mm for group isolation purpose.
- Color-yellow Base with metal or plastic strip.

MODEL	body diameter	strip material	strip size	lock hole
D25-20S		steel (Red)	200mm L X 20mm W	10mm
D25-40S	dia.59mm,	steel (Red)	400mm L x 20mm W	
D25-20P	thickness 10mm	plastic (white)	200mm L X 20mm W	
D25-40P		plastic (white)	400mm L x 20mm W	

ELECTRIC HANDLE PANEL LOCKOUT EP-D25 20CM/40CM



INDUSTRIAL PLUG LOCKOUT

Unit:mm

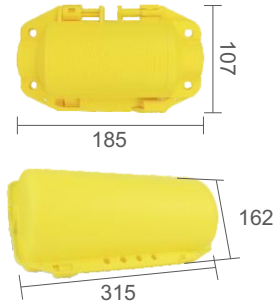

- Made from PP, sturdy and durable.
- Suitable for locking kinds of industrial plugs.
- Allow 4 padlocks to lock at the same time.
- Different colours can be customized.
- Keyhole diameter: 9.5mm.

MODEL	DESCRIPTION
EP-D33	Length*width*height: 185mm*107mm*79mm Applicable plug range: length ≤ 120, diameter ≤ 69(mm)
EP-D34	Length*width*height: 315mm*161mm*137mm Applicable plug range: length ≤ 261, diameter ≤ 114(mm)

- Made from rugged polypropylene.
- Double open and hexagon lockout design, suitable for all kinds of industrial plugs.
- Accommodates 2 to 4 pieces padlocks with shackle diameter less than 7mm to lock it at the same time.

MODEL	DESCRIPTION
EP-D41	For cables with a Dia. of 13mm
EP-D42	For cables with a Dia. of 20mm
EP-D43	For cables with a Dia. of 25mm

ELECTRICAL PLUG LOCKOUT

Unit:mm

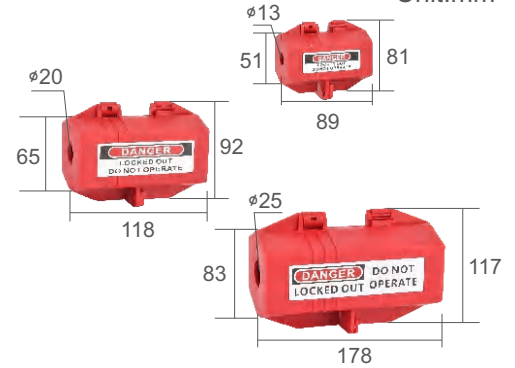

ELECTRICAL PLUG LOCKOUT

Unit:mm



Features:

- Made of engineering plastic PA+ABS;
- Insulation corrosion resistant, durable, strong, not easy to deformation, impact resistance;
- Double open cylinder lock design, can be used for all kinds of industrial plug safety lock;
- It can be locked with 2 safety padlocks with the Dia. of the lock shackles ≤ 7mm.

MODEL	DESCRIPTION
EP-D41A	Inner Dia. 58mm * inner length 95mm * hole Dia. 20mm
EP-D42A	Inner Dia. 78mm * inner length 170mm * hole Dia. 25mm

- Made from PP material, to lock industrial socket bottom.
- With hasp to lock industrial waterproof of socket.
- Can accommodate several padlocks to lock it at the same time with hasp.

MODEL	DESCRIPTION
EP-D45-1	Lockout body diameter 40mm, suitable for mini size industrial socket
EP-D45-2	Lockout body diameter 44mm, suitable for mini and middle size industrial socket
EP-D45-3	Lockout body diameter 50mm, suitable for middle size industrial socket
EP-D45-4	Lockout body diameter 63mm, suitable for middle and large size industrial socket
EP-D45-5	Lockout body diameter 73mm, suitable for large size industrial socket

INDUSTRIAL WATERPROOF SOCKET LOCKOUT

Unit:mm



INDUSTRIAL WATERPROOF PLUG LOCKOUT

Unit:mm



- Made from engineering plastic PC material.
- Suitable for locking kinds of industrial waterproof plugs.

MODEL	DESCRIPTION
EP-D46	Suitable for 16-125A industrial waterproof of plug



- The main body is made of engineering PC plastic, which is waterproof, impact-resistant, insulated and anti-leakage.
- The transparent cover realizes visual management. Easy to lock, easy to use, and prevent misoperation.
- The 3M glue installation method is convenient and efficient

MODEL	DESCRIPTION
EP-D59	Suitable for Ship-link button switch lockout size :width*length: 26mm*32mm

SHIP-LIKE BUTTON SWITCH LOCKOUT

Unit:mm



- Made from high strength transparent glass resin PC.
- Install on electrical appliance like wall switch or change over switch forever, open it then operate, avoid accidentally touch.
- Design holes on two sides. Can lock the wall plug, it is not easy to unplug.
- Can fix it by automatic screw or 3M double sided glue.
Hole dimension (length ×width): 74mm×74mm.

MODEL	DESCRIPTION
EP-D63	Suitable for wall switch or change over switch

LOCKABLE SOCKET COVERS

Unit:mm

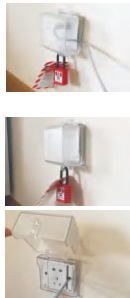
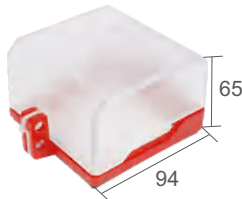

- Made from acrylic panel.
- With support rack design, can operate the panel conveniently.
- Can fix it by automatic screw or 3M double-sided tape.
- It is custom made product, the base can be coated steel or transparent mask.
- The default size:220mm*220mm,height:45mm

MODEL	DESCRIPTION
EP-D65	Can lock kinds of appliance's touch panel

CONTROL PANEL LOCKOUT

Unit:mm

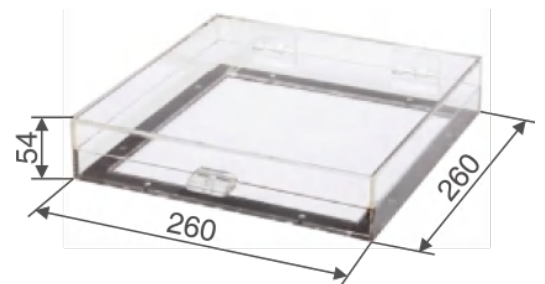

SWITCH LOCKOUT

Unit:mm

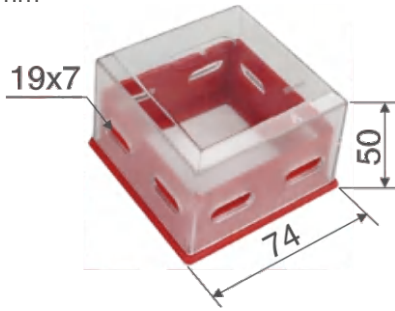

- The main cover is made of sturdy and durable engineering PC plastic, and the base is made of PA material, which has good product stability.
- The transparent cover realizes visual management, and the switch status of electrical appliances can be observed directly without unlocking operation, which is convenient to use.
- The four-sided hollow keyhole design can realize the safe management of locking by multiple people, and the locking is convenient and safe.
- The reserved hole design of the base is easy to install, and it can also be installed with 3M glue. Various installation and use methods are efficient and convenient.

MODEL	DESCRIPTION
EP-D66	Reserved holes on the base: 51mm x 51mm; Internal height:48.5mm

- The main body is made of engineering PC plastic, which is waterproof, impact-resistant, insulated and anti-leakage.
- The transparent cover realizes visual management. Easy to lock, easy to use, and prevent misoperation.
- The 3M glue installation method is convenient and efficient.

MODEL	DESCRIPTION
EP-D67	Reserved holes on the base: 51mm x 51mm; Internal height:48.5mm

SWITCH LOCKOUT

Unit:mm



LOCKOUT BAG

Unit:mm

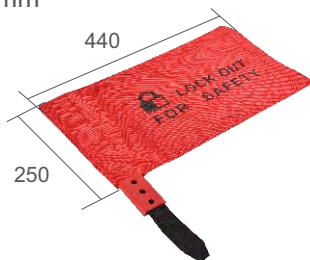

- Made from wear resisting polyester cloth.
- With PVC liner to prevent others to contact the button of the elevator controller.
- With enough space can lock many kinds of driving controller button, or all kinds of special large size plug and accessories.
- Warning labels available.

MODEL	DESCRIPTION
EP-D71	To lock by adjust the bag mouth, 6 padlocks or hasps can be equipped with
EP-D71-2	Cable lockout need to buy separately

- Made from engineering plastic alloy and A3 galvanized steel plate.
- Can lock kinds of non-standard electrical products or distribution cabinet.
- It is fixed by 3M glue or screw.
- Different shape lockouts can be custom made

MODEL	DESCRIPTION
EP-D81-1	Lock knob switch, change over switch
EP-D81-2	Lock button switch, the lock hole of the distribution cabinet
EP-D81-3	Lock cabinet door, electrical handle hole, low voltage drawer cabinet and so on.
EP-D81-4	Lock switch handle, change over switch of the drawer cabinet
EP-D81-5	Lock knife switch, handle switch and so on

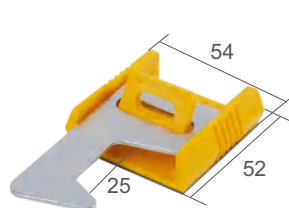

EP-D81-1

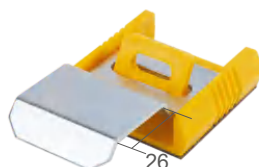

EP-D81-2



EP-D81-3

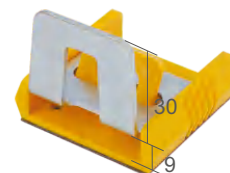

EP-D81-4



EP-D81-5

MULTIFUNCTION INDUSTRIAL ELECTRICAL LOCKOUT

Unit:mm

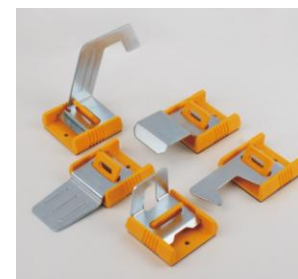

ELECTRICAL HOLE LOCKOUT

Unit:mm

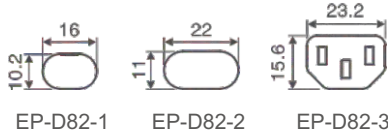

Features:

- Made from wear resisting polyester cloth.
- With PVC liner to prevent others to contact the button of the elevator controller.
- With enough space can lock many kinds of driving controller button, or all kinds of special large size plug and accessories.
- Warning labels available.

MODEL	DESCRIPTION
EP-D82-1	To lock kinds of non-standard shape, handles holes and so on
EP-D82-2	
EP-D82-3	To lock kinds of non-standard shape, handles holes and so on, 3 holes

Features:

- The lock body is made of engineering alloy plastic ABS +PC;
- Use the built-in lock cylinder to lock directly;
- Suitable for locking American standard plugs.

MODEL	DESCRIPTION
EP-D83	Use the built-in lock cylinder to lock directly, Suitable for locking American standard plugs

ELECTRICAL HOLE LOCKOUT

Unit:mm



EMERGENCY BUTTON LOCKOUT'S BASE

Features:

- Used with emergency stop lockout, such as BD-D53, BD-D55, BD-D56.
- Install on the controller button forever, avoid accidentally touch, easy to use.



EP-D50-1



EP-D50-2



MODEL	DESCRIPTION
EP-D50-1	suitable for button base's Dia.: 16mm to 22mm
EP-D50-2	suitable for button base's Dia.: 27mm to 32mm

Features:

- Made from high strength transparent glass resin PC.
- Install on the controller button forever, avoid accidentally touch.
- Color: transparent, and red.

MODEL	DESCRIPTION
EP-D51	install hole inner Dia.: 22mm
EP-D52	install hole inner Dia.: 30mm

EMERGENCY STOP LOCKOUT

Unit:mm



EP-D51

EP-D52

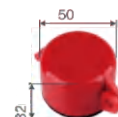

EMERGENCY STOP LOCKOUT

Unit:mm

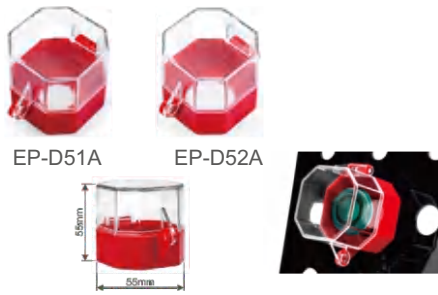

Features:

- Made from high strength transparent glass resin PC.
- Install on the controller button forever, avoid accidentally touch.
- Color: transparent, and red.

MODEL	DESCRIPTION
EP-D51A	install hole inner Dia.: 22mm
EP-D52A	install hole inner Dia.. 30mm

Features:

- Transparent high-strengthened glass resin PC material.
- No need disassemble, easy to install, just install the base on the bottom of the emergency stop switch. it can be locked and removed at will.
- Permanently installed on the emergency stop button which can push-pull or screw release to prevent accidental touch.
- According to the reserved holes of the lock, it can be locked with 2-4 safety padlocks with the Dia. of the lock beam≤7mm can be locked

MODEL	DESCRIPTION
EP-D53	Inner Dia.55mm * inner height 43mm, hole Dia.46mm
EP-D55	Inner Dia.65mm * inner height 49mm, hole Dia.46mm
EP-D56	Inner Dia.54.5mm * inner height 64mm, hole Dia.45.5mm
EP-D53-2	Suitable for inner Dia.22/30mm hole button base
EP-D53-3	Suitable for inner Dia.22mm hole button base
EP-D53-4	Suitable for inner Dia.30/38mm hole button base

EMERGENCY STOP LOCKOUT

Unit:mm

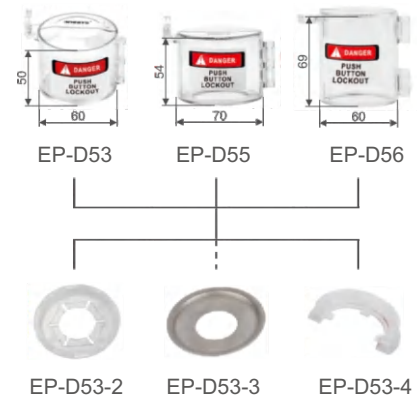

EMERGENCY STOP LOCKOUT

Unit:mm

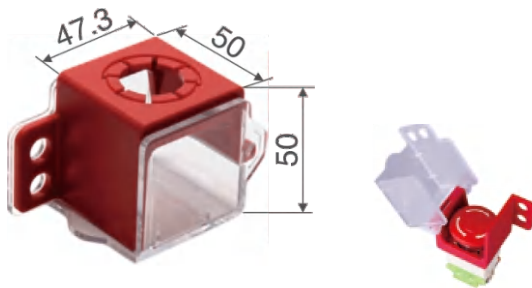

Features:

- Made from high strength transparent glass resin PC.
- Avoid unpick, install easily, install the base on the bottom of the emergency stop switch, can lock and remove at random.
- Install on the push or spiral release emergency stop button, avoid accidentally touch.
- When no need lock at ordinary time, leave the base at site, not affect the operation at all. Put the cover to lock the base if necessary.

MODEL	DESCRIPTION
EP-8134	Length: 50mm, width:47.3mm, height: 50mm Installing hole inner diameter: 22 or 30mm

Features:

- Made from high-strengthened transparent glass resin PC.
- Avoid dismantling, easy to install, install the base on the bottom of the emergency stop switch, can lock and remove at random.
- Install on the push or spiral release emergency stop button, avoid accidentally touch.
- When no need to lock at ordinary time, leave the base at site, will not affect the operation at all. Put the cover to lock the base when necessary.

MODEL	DESCRIPTION
EP-D57	hole's diameter: 57mm; wall thickness: 3mm
EP-D57-1	Suitable for hole button bases with an inner diameter of 34-50mm
EP-D58	hole's diameter: 80mm; wall thickness: 2mm
EP-D58-1	Suitable for hole button bases with an inner diameter of 24-67mm

EMERGENCY STOP LOCKOUT



EMERGENCY STOP LOCKOUT

Unit:mm



EP-D60-1

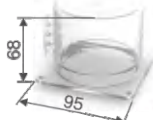

EP-D60-2



EP-D60-3



EP-D60-4

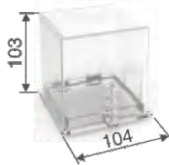

EP-D60-5

Features:

- Transparent high-strengthened glass resin PC material.
- No need disassemble, easy to install, just install the base on the bottom of the emergency stop switch. it can be locked and removed at will.
- Permanently installed on the emergency stop button which can push-pull or screw release to prevent accidental touch.
- According to the reserved holes of the lock, it can be locked with 2-4 safety padlocks with the Dia. of the lock beam ≤ 7mm can be locked

MODEL	Dimensions inside the base	Inner height of the base
EP-D60-1	Dia.27.5mm	42mm
EP-D60-2	Dia.75mm	65.5mm
EP-D60-3	50*50mm	60mm
EP-D60-4	70*70mm	61.5mm
EP-D60-5	84*84mm	100.5mm

Features:

- Patented product design. It can realize the true meaning of the rapid assembly and disassembly, without the aid of glue or other auxiliary facilities such as a screwdriver
- lock only the base set in the switch, press the lower part of the metal base, clockwise rotation on the part of the nylon base, the base can be fixed, convenient
- The lock cover is made of high transparent ABS plastic, diameter 62mm height 54mm can accommodate most of button

MODEL	Lock range
EP-8135	17-23mm
EP-8136	27-32mm
EP-8137	32-35mm

Disassembly-free emergency stop lock

EP-E34 lock for outer diameter of 22-27mm
 EP-E34A lock for outer diameter of 27-32mm



Description:

disassembly-free emergency stop lock is designed for emergency stop buttons, especially when they cannot be disassembled or touched.

Features:

- No need to disassemble any parts, it can be locked by rotating, and assembly and disassembly are quick.
- The toothed holder of stainless steel 304 and the clamping piece of nylon fiberglass provide a more stable locking method, effectively improve the overall weather resistance and extend the service life.
- The lock cover is made of highly transparent engineering plastic, which is resistant to falling and will not crack.

EMERGENCY STOP LOCKOUT



Button switch lock

EP-E39



Description:

Can lock button switches with labels and lock various button switches at close range at the same time

Features:

- Scope of application: The maximum outer diameter of the button is $\leq 32\text{mm}$, and the center distance of the button is $\geq 50\text{mm}$.
- Made of transparent engineering plastic, tough and durable.
- Solve the problem of requiring locking at close range, with tags, and multiple targets.
- Comes with 3M adhesive base, which is firm, convenient and traceless to install.
- The lock cover can be locked by rotating 180 degrees, and the locking hole diameter is 6.5mm, which is very fast.
- The outer diameter of the lock cover and base is only 50mm, adapting to more button switches in narrow spaces.

Description:

When many transfer switches or gear switches need to be locked, the switch itself often needs to be disassembled. The whole process is time-consuming and cumbersome. This lock is ready to use and locks quickly and easily. The highly transparent plastic material not only insulates the inside of the switch, but also makes it easy to observe. Condition.

Features:

- Simple design, no need to remove the switch, most transfer switches can be locked
- Fast locking/removal
- Internal effective diameter 80mm, height 40mm, central aperture 20mm

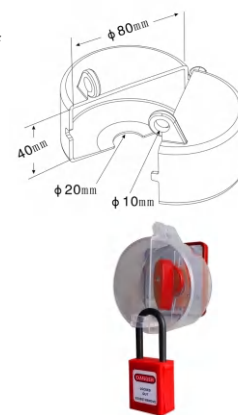

Universal transfer switch lockout

EP-E41



Multifunctional switch lock

EP-V52

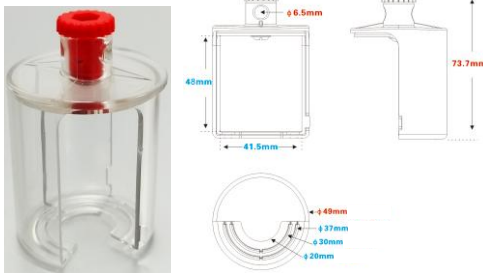

Description:

It can lock emergency stop switches, flow adjustment switches, pressure valve switches and other cap-shaped switches with anti-accidental touch bases, and has a wide range of uses.

Features:

- Made of highly transparent engineering plastic, beautiful, durable and not fragile
- Rotate 180 degrees to complete, and locking is simple and convenient
- The three diameters of the bottom bayonet are 20mm, 30mm and 37mm. The bottom reserved edge strip can be cut to change the caliber according to the needs of the site. It can be switched freely and is more adaptable.
- The product can accommodate switches with a height of 48mm and a diameter of 41.5mm. The locking hole diameter is 6.5mm and can accommodate most security padlocks.

- Completely enclose electrical plugs to prevent accidental re-connection
- ABS Material, impact resistant

MODEL	Size	Cable & hole dia
EP-E81	100mm Length × Diameter 61mm	Cable dia 12.5mm, Hole 10mm
EP-E82	180mm Length × Diameter 83mm	Cable dia 25mm, Hole 10mm

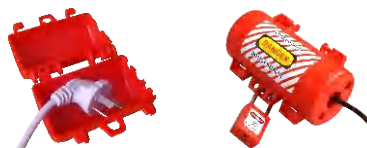

ELECTRICAL PLUG LOCKOUT



VALVE LOCKOUTS AND HOSE LOCKOUTS

Valve lockout devices shutoff many kinds of pressured valves including: ball valve, butterfly valve, cylinder valve, gate valve, plug valve and pneumatic. Adjustable and universal devices are available for additional flexibility

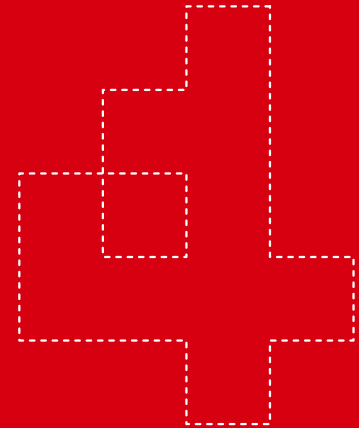

BALL VALVE LOCKOUT

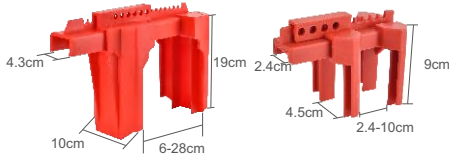

- Easy to use, single-piece design makes our standard ball valve lockouts the perfect tool for securing your valve handles in the off position.
- Material: Polypropylene

Part No.	Locks out pipe in diameter	Hole diameter for shackles
EP-8210	0.25"-2.5"	3/8" lock holes
EP-8211	2" to 8"	3/8" lock holes



- Easy to use, single-piece design makes our standard ball valve lockouts the perfect tool for securing your valve handles in the off position. Hole diameter accept 3/8" padlock shackles.
- For use on ball valve sizes from 0.25" to 1" (3/8" lock holes)

BALL VALVE LOCKOUT

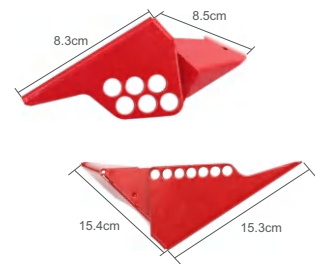

Part No.	Locks out pipe in diameter	Hole diameter for shackles
EP-8208	0.25" to 1"	3/8" lock holes
EP-8209	1.25" to 3"	9/32" lock holes



ADJUSTABLE BALL VALVE LOCKOUT

- Made of high strength polypropylene plastic
- Fully insulated
- Anti solvents and other chemical
- The fracture resistance and wear resistance
- Applicable temperature range: -50°F (-46 °C) to 360 °F (182 °C)

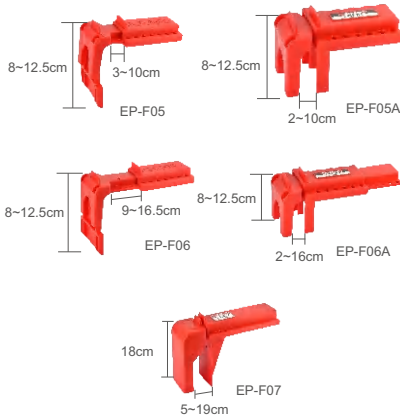

Part No.	Fit for ball valve size
EP-F05	0.375"-0.25"(9.5mm-31.5mm)
EP-F05A	0.375"-0.25"(9.5mm-31.5mm) With auxiliary rear gear parts
EP-F06	1.5"-2.5"(37.5mm-62.5mm)
EP-F06A	1.5"-2.5"(37.5mm-62.5mm) With auxiliary rear gear parts
EP-F07	2"-8"(50mm-200mm)



- Made from Zinc alloy, surface treatment by high temperature spray plastic, not easy to rust.
- Used to lock industrial ball valve.
- Maximum padlock diameter: 7mm.
- Color: red, other colors need to be customized.
- Suitable for all ball valves with a thickness of ≤ 10 mm.

ADJUSTABLE BALL VALVE LOCKOUT

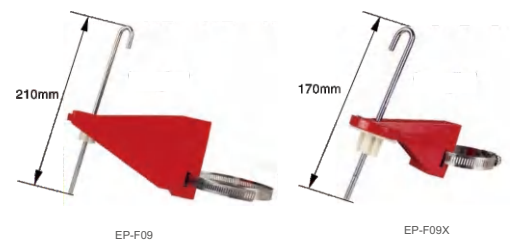

Part No.	Description
EP-F09	size: 163*56*186 Suitable for handle length ≤ 150 mm
EP-F09X	size: 108*49.5*155 Suitable for handle length ≤ 120 mm



FLANGE BALL VALVE LOCKOUT BAG



- The bag body is made of PC wear-resistant material, which is durable in harsh environment.
- 3pcs safety padlocks (Diameters ≤ 7mm) can lock on at the same time.
- The lock bag comes with a handle storage bag to store the matching locks, which is convenient and efficient to use, can prevent the locks from being lost.
- The fixed belt is made of PP, which makes the lock bag more stable and effective.

Part No.	Description
EP-F10	valve head diameter ≤ 30mm



Made of injection-molded polypropylene, our gate valve lockouts are extremely rugged for superior impact and chemical resistance. They can easily withstand temperatures from -20°F to 300°F. Unique knockout center accommodates OS&Y or "rising stem" valves. Lockouts accept locks with shackles up to 3/8" diameter. Danger labels in English, Spanish and French are included.

GATE VALVE LOCKOUT

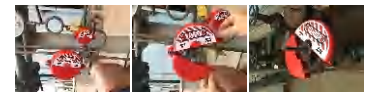

Part No.	Hole diameter	inner height	fit for valve handle diameter
EP-8231	19mm	30mm	25mm-64mm(1"-2.5")
EP-8232	44mm	35mm	64mm-127mm(2.5"-5")
EP-8233	63mm	40mm	127mm-165mm(5"-6.5")
EP-8234	90mm	60mm	165mm-254mm(6.5"-10")
EP-8235	105mm	60mm	254mm-330mmz(10"-13")

NEW GATE VALVE LOCKOUT



- Made from imported DuPont engineering plastics.
- The different size semicircle design, two parts can be combined into one when storing and carrying. reduce a half volume. Lock the handwheel diameter 25mm-450mm (1"-18") valve (as sheet description).
- Locked by 4 pcs padlocks, locked shackle diameter ≤ 7mm.
- Color: red, other colors need to be customized. Label can be customized.

Part No.	Hole diameter	inner height	fit for valve handle diameter
EP-F11A	19mm	30mm	25mm-64mm(1"-2.5")
EP-F12A	44mm	35mm	64mm-127mm(2.5"-5")
EP-F13A	63mm	55mm	127mm-165mm(5"-6.5")
EP-F14A	90mm	75mm	165mm-254mm(6.5"-10")
EP-F15A	105mm	70mm	254mm-330mmz(10"-13")
EP-F15plus	123mm	65mm	330-mm-450mm(10"-18")
EP-F15B	130mm	63mm	450-mm-600mm(18"-24")

- Economical lockout adjusts to fit 1"(25mm) to 6 1/2"(165mm) diameter valve handles,
- Replacing 3 conventional gate valve lockouts.
- Durable polypropylene is resistant to extreme temperature changes from -13°F to 194°F.
- Device is compact for easy carrying and storage

Part No.	Dia of valve Handle	Dia of padlock
EP-8241	25-165mm	9.5mm

ADJUSTABLE GATE VALVE LOCKOUT



ADJUSTABLE BUTTERFLY VALVE LOCKOUT

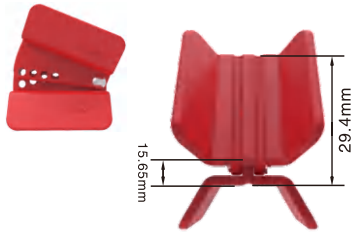

- Made from Polypropylene PP.
- Suitable for Butterfly Valve.
- Appearance: Red.
- Use with 4mm diameter cable lock.

Part No.	Description
EP-F20	Adjustable angle: 15°~36°

- Made from engineering plastic strengthened nylon PA and stainless steel.
- Fit the new open-ended clamp over the closed ring, used to lock out the large handle,
- Also can used to Large leverage ,T-shape handles and other hard-to-secure mechanical devices
- Cable accessories can be used 3.2mm (1/8 ") PVC stainless steel metal cable coated by PVC.
- Suitable for gate valve, ball valve, butterfly valve and so on.

UNIVERSAL VALVE LOCKOUT

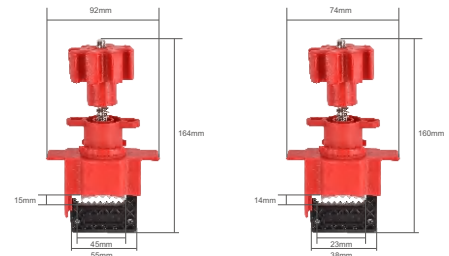

**EP-8212/8213/8222
8236/8237**
For maximum handle width: 40mm
Max handle thickness: 28mm
Arm length: 200mm
height of the support rod: 170mm

**EP-8212X/8213X/8222X
8236X/8237X**
For maximum handle width: 40mm
Max handle thickness: 28mm
Arm length: 200mm
height of the support rod: 170mm

Part No.	Key System
EP-8212/8212X	Single Arm Universal valve Lockout/Small Single Arm Universal valve Lockout
EP-8213/8213X	Double Arm Universal valve Lockout/Small double Arm Universal valve Lockout
EP-8222/8222X	Universal Valve lockout/Small Universal Valve lockout
EP-8236/8236X	Universal Butterfly Valve lockout/Small Universal Butterfly Valve lockout
EP-8237/8237X	Universal Valve lockout/Small Universal Valve lockout



EP-8212



EP-8213



EP-8222



EP-8236



EP-8237

VALVE LOCKOUT



- The lock body is made of Engineering plastic PC.
- toothed carbon steel sheet and stainless steel screws.
- With self-contained tightening screw, easy to lock by yourself without tools.
- 192mm(height)*94mm(width)*32mm(thickness)(without screw length).
- Applicable locking range: 31mm-100mm.
- Maximum padlock diameter: 7mm.

Part No.	Description
EP-F36-1	Suitable for locking butterfly valves
EP-F36-2	Suitable for locking valves

PLUG VALVE LOCKOUT



Plug Valve Lockout is the first lockout device to easily and effectively secure a manually-actuated plug valve with a stem diameter up to 7/8". The base of the lockout device can remain in place once applied, and generally does not interfere with valve activation by wrench or removable handle. The device is compact in size, yet highly-visible and easy to use and made of durable polypropylene.

Part No.	Valve Diameter
EP-V41	0.375" - 0.875"
EP-V42	0.938" - 1.375"
EP-V43	1.750" - 2.125"
EP-V44	2.187" - 2.500"

- Made from metal alloy and engineering plastic.
- Available for 4 padlocks at the same time.
- Color: red.

Part No.	Description
EP-FL01	Applicable to stem diameter 13mm-19mm (1/2"-3/4")
EP-FL02	Applicable to stem diameter 23mm-32mm (7/8"-1-1/4")
EP-FL03	Applicable to stem diameter 35mm-47mm (1-3/8"-1-7/8")



BLIND FLANGED LOCKOUT DEVICE



Ball Valve Lockout

EP-V18

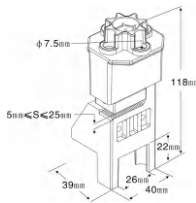

Discription:

Light and small especially for small ball gate and limited space.

Item: New ball gate lockout

V18 Model: V18

Package: 1pc/box

Advantage:

1. Light and small especially for small ball gate and limited space.
2. Made of engineering plastics and alloy material, can lock right angle ball and less-than 1" open ball valve.

Discription:

Universal butterfly valve lockout is very tiny and lightweight, for the regular butterfly valve

Packaging : 1pc/box

Material: Made of power-coated steel

Advantage:

- 1 New design for the shape, very tiny and use widely . More flexible because of the side opening design
- 2 T-type part fastness the butterfly valve jaw firmly, keep the valve on the right position
- 3 Fits for handle thickness between 5 – 25mm
- 4 Good impact resistance and excellent chemical resistance is the best choice in universal butterfly valve lockout

Universal butterfly valve lockout(S)

EP-V21

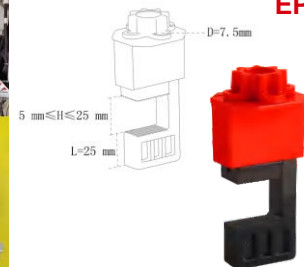
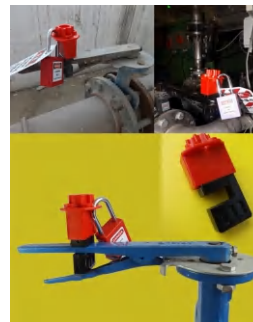

Butterfly valve lockout

EP-V23

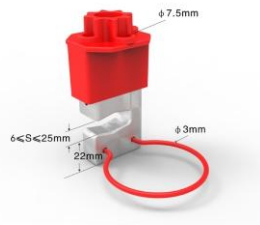

Description:

- Patented locks, designed specifically for the special butterfly valves
- Metal parts material 304 stainless steel, strong corrosion-resistant and never rust
- Lock convenient, wide locking range, versatility
- Special V-jaws, clamped firmly against the round handle

Description:

- Description: Mainly used for locking sanitary butterfly valves

Features:

1. Made of engineering plastics, strong and durable
2. Patented package structure design, easy to lock and easy to operate
3. It can lock most of the existing sanitary butterfly valves
4. With 2 diameter 8mm and 1 diameter 6.5mm upper lock holes

Sanitary butterfly valve lock

EP-V24



Plug Valve Lockout

EP-V41

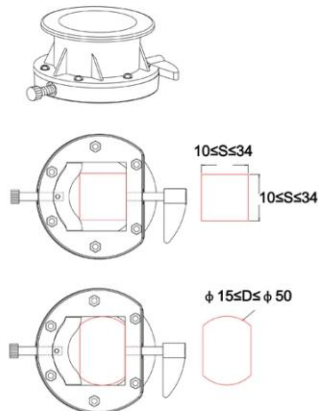
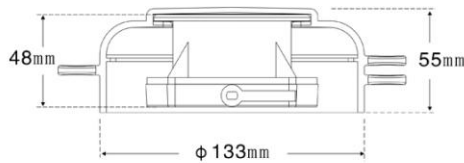

Description:

Designed for the locking device can remove the ball valve handle design, locks consists of two parts, the lock housing is reinforced nylon and fiberglass material, wear resistance, high temperature, the base is 304 stainless steel Nylon, durable

Small volume light weight product, easy to carry.

Features:

1. Adapt to a wide range of products, and can lock square and round two kinds of stem. Square can accommodate the size of the 10--34mm. Diameter circular 15--50mm
- 2 locking process without the aid of any tools, full manual, three located on the top two-way clamping



- The Handle-On Ball Valve Lockout features durable aluminum & steel construction to defy corrosive environments and extreme temperatures.
- The patent-pending lightweight and compact device is designed to clamp tight on handle stop to prevent handle movement.
- It can be applied to 1/4in (6mm) to 4in (102mm) sized valves and works on insulated pipes and in close quarters

HANDLE-ON BALL VALVE LOCKOUT

Model: EP-S3068



MULTI-PURPOSE CABLE LOCKOUT



Cable length: 2.4m
Cable diameter: 3.5mm

- Made from impact resistant engineering plastic nylon PA, can be customized other colors.
- Used 2.4meter stainless steel cable, the outer layer of cable is made from anti-UV PVC with diameter of 3.5mm
- The cable can be customized with different length and color.
- Locked by our normal padlock

Part No.	Description
EP-L01	Cable lockout, length 2.4M, diameter 3.5mm

- Made from impact resistant engineering plastic PC, can be customized other colors.
- Used 1.8 meter cable, the outer layer of cable is made from anti-UV PVC (diameter 6mm), the cable can be customized with different length and color
- With Extra temperature of -46°C -149°C
- Locked with 4 padlock, lock shackle diameter is less than 7mm

ADJUSTABLE CABLE LOCKOUT

Part No.	Description
EP-L11	Cable lockout, length 2M, diameter 6mm



Handle color: red & black
Can be customized

ECONOMIC CABLE LOCKOUT

Cable length: 2.0m
Cable diameter: 4mm



- Made from impact resistant engineering plastic PC, can be customized other colors.
- Used 2meter cable, the outer layer of cable is made from anti-UV PVC (diameter 4mm), the cable can be customized with different length and color
- With Extra temperature of -46°C -149°C
- Locked with 4 padlock, lock shackle diameter is less than 7mm

Part No.	Description
EP-L21	Cable lockout, length 2M, diameter 4mm

- Our re-usable cable lockout device is ideal for securing most valves, isolators and industrial machines.
- Manufactured from an impact resistant copolymer polypropylene
- Stainless steel internal parts
- Supplied with 1.5 metre PVC coated, heavy duty steel cable
- Cable slotted in from side and locked with the special locking tool
- Will accept up to 6 padlocks for multiple lockout applications
- DERA Tested between temperatures +55°C to -55°C with no noticeable reduction in performance

WHEEL TYPE CABLE LOCKOUT

Part No.	Description
EP-L31	Cable lockout, length 2M, diameter 4mm



Cable length: 2.0m
Cable diameter: 4mm

AUTOMATIC RETRACTABLE CABLE LOCKOUT

Unit:mm



- Material: Automatic retractable cable lockout is made of Polycarbonate Plastic(PC), impact resistance , abrasive resistance , heat resistance, low temperature, can withstand the temperature of -35°C to 85°C.
- Function: Automatic retraction ,press the winding switch button, the cable can automatic retract and hidden in the lockout; maneuverable, portable, durable.
- Cable Diameter: 2.0mm
- Socket:7*4.5mm
- Padlock Shackle Diameter: ≤7mm
- Padlock Quantity:2PCS

Part No.	Description
EP-L41	110mm*110mm*40mm

Cable lockouts are incredibly versatile making them perfect for all of your unusual energy isolating devices that are difficult to lock out. Compact, lightweight body is made of rugged impact modified glass filled nylon giving them superior chemical, corrosion and temperature resistance properties. Sheathed metal cable is 3/16" diameter including vinyl coating. Ergonomic design makes it a "cinch" to tighten cable - hold device in one hand and cinch tight with the other! Built-in cable loop keeps cable neatly coiled when stored and prevents it from dangling loose when device is being used. 4 lock holes in handle accommodate most lock shackles and hasps

Part No.	Description
EP-L51	Cable lockout, length 2M, diameter 4mm
EP-L51-1	Steel cable: diameter 5mm*2.5m

MULTIPURPOSE CABLE LOCKOUT



EP-L02

ALL PURPOSE CABLE LOCKOUT WITH 8' SHEATHED CABLE



- Made from impact resistant engineering plastic nylon PA.
- Used 2.4 meter stainless steel cable, the outer layer of cable is made from anti—UvPvG(diameter 3mm or 4mm).
- Innovative self-locking function, the cable lock is self-locking when it is not operated, to ensure that the cable is not stretched at will, and the locking function is powerful.
- Permanently write labels (Chinese, English or other languages customized) to identify the operator.
- Locked with 5 pad lock, lock shackle diameter is less than 7mm.

Part No.	Description
EP-L02	Cable diameter: 3mm
	Cable diameter: 4mm

This cable lockout is an ideal device for locking cable device.

- Made from impact resistant engineering plastic nylon PC and brass parts, can be customized other colors.
- Used 2 meter stainless steel cable, the outer layer of cable is made from anti-UV PVC (diameter 4mm).
- The cable can be customized with different length and colors.
- Comes with a lock handle, easy to use.
- Locked with lots padlocks, lock shackle diameter is less than 7mm.

Part No.	Description
EP-L32	included cable, without auxiliary tools, can complete lock step by hands

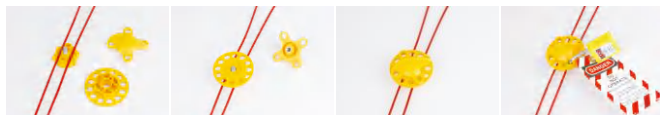

WHEEL TYPE CABLE LOCKOUT

Cable length: 2.0m
Cable diameter: 4mm



NEW MULTI-PURPOSE CABLE LOCKOUT



Appearance Function Patent

- Lock body is made from impact resistant engineering plastic ABS, can be customized other colors.
- Used 2meter stainless steel cable, the outer layer of cable is made from anti-UV PVC with diameter of 3mm
- The cable can be customized with different length and color.
- Can Lockable gate valve, adjacent multiple lock points, can also be used as a slim padlock
- Standard 33*56mm "Danger" label and write on properly labels included front and back.
- This lock achieves a perfect unification of padlocks and cable locks.

Part No.	Description
EP-L13	Cable lockout, length 2M, diameter 3mm

- Body size-5 in H x 2.4 in W x 1 in D(127 mm H x 61 mm W x 25.4 mm D)
- Body Material-Polycarbonate
- Cable is made of stainless steel or steel with insulated cover
- Flexible, cost-effective cable locks out gate valves of all size and may be used to lock out multiple valves
- Lighter than chains,device is easy to carry and easy to use
- Maximum Number of Padlocks-6

Part No.	Cable length and diameter	Cable color	Cable Material
EP-L71S	Cable lockout, length 2M, diameter 3mm	silver	Steel
EP-L71N	Cable lockout, length 2M, diameter 3mm	red	Steel with insulated cover

UNIVERSAL CABLE LOCKOUT

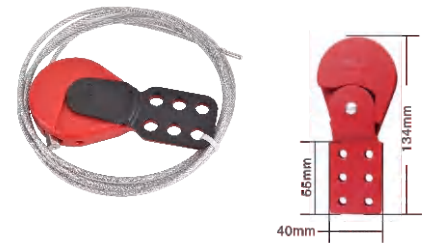

CABLE LOCKOUT

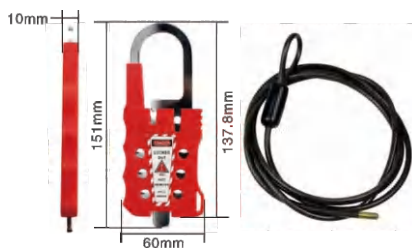

EP-L22

- Made of ABS+PC.
- Used 1.8 meter stainless steel cable ,the outer layer of cable ismade from anti-UV PvC (diameter 4.8mm).
- Allow 6 padlocks with lock shackle less than 7mm.
- Colour: red.

Part No.	Description
EP-L22	Include cable

Code: EP-C11

Description:

Cable locks can lock the patriarch of various sizes, can lock multiple electrical cabinet switch lock, easy to carry, versatile,3mm diameter cable length 2m with insulation

Features:

- The patented design of the cable locks in both the use and storage of the cable can be tightened inside the lock body, use and storage are very convenient. To prevent more than a cable and other field equipment
- Other products wound inflicted accidentally.
- The new way of tightening, avoid hand-tighten the rope is too small or too slick to hurt the hand is not easy to tighten. Easily achieve the rotating mandrel retractable cable.

New type cable lockout

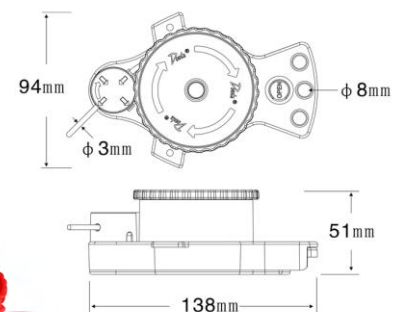

Cable Lockout

Code: EP-C13

Description: This cable lock has a built-in lock core and does not need to be used with other padlocks. It can lock the gate valve/multiple adjacent locking points and can also be used as a padlock. One lock has multiple uses and has a wide range of uses.

Features:

- It is unique appearance and structure patented technology, available in 4 colors: red, yellow, blue and green, other colors can be customized
- The lock cylinder is built-in and the key opens directly, no need to use it with a padlock.
- The cable has a diameter of 3mm and can be used through small keyholes and narrow spaces.
- During use, the cable can be continuously tightened to prevent loosening and lock more firmly.
- Integrated interlocking structure, strong and durable
- There are 33*56mm warning labels on the front and back of the lock body (the content can be customized)
- Key system can be KD, KA, MK.

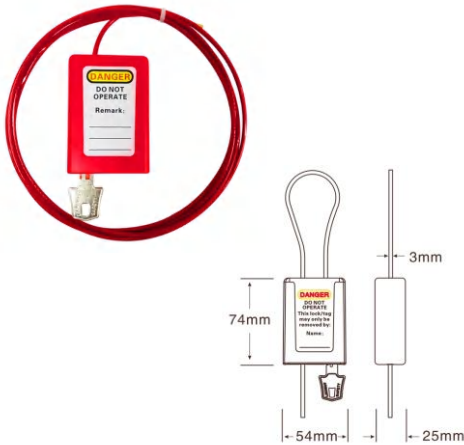

1. Color: 4 colors are available: red, yellow, blue, and green, and color customization services are provided.
2. Lock beam material: 304 stainless steel plastic-coated steel cable.

Product description:

1. The lock shackle is a stainless steel plastic-coated steel cable with a diameter of 2mm. Standard length is 20cm, length can be customized.
2. After locking, you can continue to tighten the steel cable lock shackle
3. Various levels of management locks can be quickly customized
4. Full copper lock core, grade 6 marble, extremely low mutual opening rate
5. Special structural design, isolation current From lock beam to key
6. One lock, one key, compliant with OSHA standards
7. The lock body is made of engineering plastic, tough and lightweight

Thin Steel Cable Padlock

EP-C51S



Cable Lockout

EP-C15



Description: Lock single or multiple adjacent switches. After the key is pulled out, the steel cable can still be tightened infinitely, and multiple people can be locked at the same time.

Features:

1. Patented product, the hand can be held loosely/tightly, and can be tightened after locking, making it easy and firm to use.
2. The standard steel cable length is 2m and the diameter is 3mm. The length can be customized.
3. Equipped with 7 locking holes with a diameter of 8mm, suitable for multiple people to lock at the same time.
4. Made of engineering plastic, one-piece molding, non-welding process, tough and durable.
5. With eye-catching large-area writeable labels for easy management and identification.

SIMPLE CABLE LOCKOUT

Unit:mm



Metal cable



Insulated cable

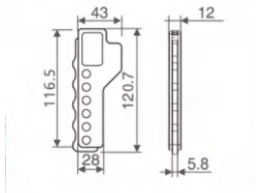

Product Features

- The lockout body is made of engineering plastic nylon PA
- The outer layer of the cable is made of UV-resistant PVC, and the inner material is divided into two materials: insulation and metal (stainless steel);
- Customizable labels. (Chinese, English or multilanguage customization)

Part No.	Description
EP-L61	dia 3mm x length 1.8m, Metal cable dia 4mm x length 1.8m, Metal cable dia 5mm x length 2.4m, Insulated cable

Product Features

- The lock body is made of painted die-cast aluminum;
- It can be locked with 8 safety padlocks with shackle Dia. s 7mm;
- Colour: lacquered silver or lacquered red.

Part No.	Description
EP-AL61	dia 3mm x length 1.5m, dia 4mm x length 1.5m

SIMPLE CABLE LOCKOUT

Unit:mm



Painted silver



Painted red

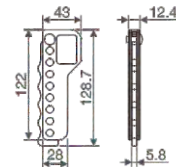

SIMPLE STAINLESS STEEL CABLE LOCKOUT

Unit:mm

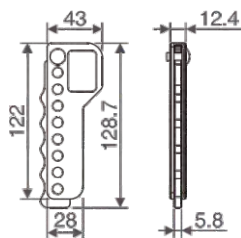

Product Features

- The lock body is made of die-cast stainless steel.
- It can be locked with 7 safety padlocks with shackle Dia. s 7mm.

Part No.	Description
EP-SL61	dia 3mm x length 1.8m, Metal cable dia 4mm x length 1.8m, Metal cable dia 5mm x length 2.4m, Insulated cable

Pneumatic Lockouts

Pneumatic hose lockouts are critical for de-energizing and isolating compressed air sources of power. Our pneumatic quick-disconnect lockouts easily attach to the male fitting, effectively prohibiting any pneumatic connection without the inconvenience of installing in-line lockout valves. It is also convenient for storage and holding the air hose while it's not in use, keeping your facility orderly and air hoses from getting tangled. Air Line lockouts will snap on over the regulator knob to deny access to the air line regulator.

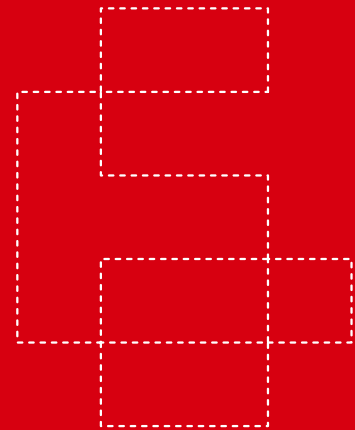

GAS SUPPLIER LOCKOUT



Item No.: EP-Q01

- Made of stainless steel , excellent corrosion resistant.
- Size:35mm×196mm×3mm
- used with hasp.



Item No.: EP-Q11

Description:

- Our pneumatic quick-disconnect lockout is applied to the male fitting, isolating equipment from all compressed air sources.
- Device accommodates the majority of 1/4"(6.4mm), 3/8"(9.5mm) and 1/2"(12.7mm) male fittings.
- Hole in center of device allows for permanent storage on an air hose and a loop on the side can be used to hang the hose and lockout device.

PNEUMATIC QUICK-DISCONNECT LOCKOUT



CYLINDER TANK LOCKOUT

Item No.: EP-Q21~Q24

- Revolutionary new rugged polystyrene plastic device is used to lockout cylinder tanks, including propane tanks on fork trucks and stand alone propane tanks. Special design allows device to be used in tight spaces. Valve stem hole is 1.25" in diameter.



Part Code	Aperture	Inner diameter	Keyhole diameter	Inside height	Description
EP-Q21/EP-Q21T	30	80	8	25	Suitable for hole diameter less than 3.0mm
EP-Q22/EP-Q22T	30	100	8	25	Suitable for hole diameter less than 3.0mm
EP-Q23/EP-Q23T	30	60	8	25	Suitable for hole diameter less than 3.0mm
EP-Q24/EP-Q24T	30	60	8	45	Suitable for hole diameter less than 3.0mm



PC material



ABS material

GAS CYLINDER LOCKOUT



Product Features

- Made from engineering plastic PP.
- Prevents access to the main cylinder valve without authorization
- No need to match your lockout device to varying Dia. and threads of cylinder caps.
- Can be used for the maximum Dia. 80mm of the neck ring.
- Can be locked with 3 padlocks, lock shackle Dia.< 7mm.

Part No.	Description
EP-Q31	Max 80mm of the neck ring



Product Features

- Made of High density polyethylene(HDPE).
- Prevent chemical substances from being discharged into the environment and prevent dirt particles from polluting chemicals.
- Can be locked with 3 padlocks, lock shackle Dia.< 7mm.

Part No.	Description
EP-Q110	oil drum hole with 82-88mm outer Dia.

OIL DRUM LOCKOUT

Unit:mm

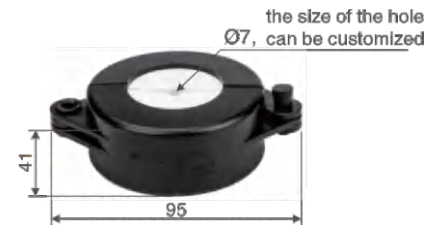

CLAMP OIL DRUM COVER LOCKOUT

Unit:mm

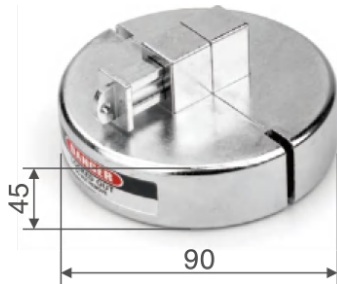

Product Features

- Made of corrosion resistance of aluminum alloy.
- lock the Items of the barrel safety.
- Installed around the barrel plug angle without risk of cross threading
- Can be locked with padlocks, lock shackle Dia. ≤ 7mm.

Part No.	Description
EP-Q120	oil drum hole with 72-85mm outer Dia

Product Features

- Main body made of PA66+20%GF,Black sealing ring is nitrile rubber
- Protect the Items of the barrel safety.
- Butterfly nut rotates clockwise ,and expand the gasket, forming a liquid and gas tight seal.
- Can be locked with padlocks, lock shackle Dia. ≤ 7mm.

Part No.	Description
EP-Q130	oil drum hole with 72-85mm outer Dia

SPIRAL OIL DRUM LOCKOUT

Unit:mm

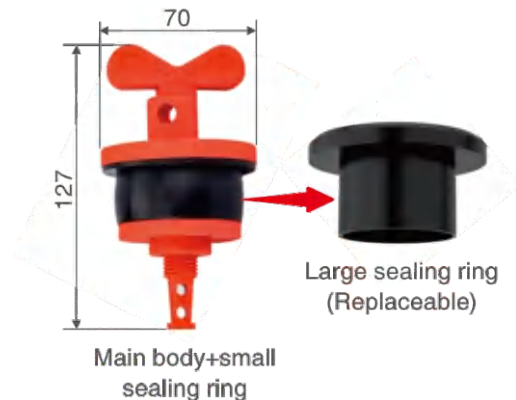

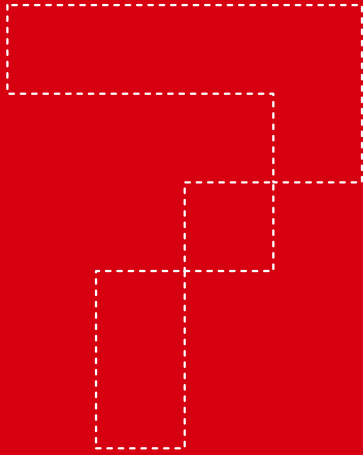

LOCKOUT TAGOUT STATIONS AND LOCKOUT TAGOUT KITS

Lockout stations and kits are equipped with the tools you need to isolate mechanical and electrical control points. These stations are portable or static and work for just about any application.



Model	Description	size
EP-8811	Group Lockout Box with 12 holes + 1 main locking hook on side are made of metallic material sheet with power coating having multiple slot for padlocks and lockable arrangement.	260x110x105mm
EP-8812	Group Lockout Box with 12 holes + 1 main locking hook on side are made of metallic material sheet with power coating having multiple slot for padlocks and lockable arrangement.	260x110x155mm



Model	Description	size
EP-8821	Multipurpose Padlock Cabinet for keeping 30locks with locking arrangement of individual key different + one Master key to operate all different cabinet,	560x460x70mm



EP-8821



Example of lockout products mounting

Model	Description	size
EP-B14	Clear visible window in the side edge. After the equipment to be worked on has been isolated from the energy source, the lockout keys are placed inside the multiple lockout kit and then working applies their own unique padlock to the lockout kit <ul style="list-style-type: none"> • Carbon Steel material with baking finish, very smoothy and bright • Multiple lockout kit Allow 13 people , ensure the security. • The diameter of the lock hole is 7mm 	100x200x240mm

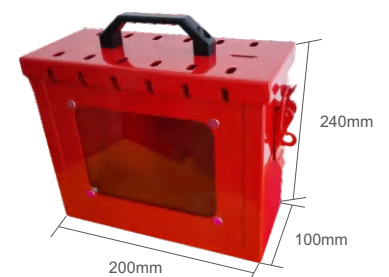

Model	Description	size
EP-B13	<p>Wall mounted and portable multiple holes lock box, Each device lock point, can be locked by a single padlock to ensure safety, and take these keys in the lock box, then each authorized worker sets his own padlock on the box. When the work is completed, each authorized worker removes his own padlock from the lock box, then the box is open, the inside keys can be got.</p> <ul style="list-style-type: none"> • Material: super resistance steel spray powder. • Unique design, convenient and practical. <p>Allows a maximum of 14 persons to lock out, built-in 12 hooks, provide at least 12 keys storage. Four points to wall mounted and top part equipped with handle, can be carried to required places.</p>	190x90x330mm



SMALL HANDING STEEL SAFETY LOCKOUT KIT

Model	Description	size
EP-X21	<ul style="list-style-type: none"> ●made of engineering plastic ABS and PC, ●with transparent cover. ●can be locked by padlocks with shackle diameter less than 7mm. ●can be locked by 8 safety padlocks at the same time, convenient for administration. ●it has 6 hooks inside and 2 hooks outer. 	98*180*120mm

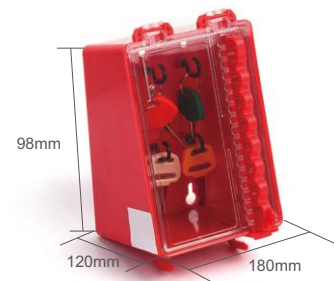

Model	Description	size
EP-X22	<ul style="list-style-type: none"> ●made of engineering plastic ABS and PC, ●b.with transparent cover. ●can be locked by padlocks with shackle diameter less than 7mm. ●can be locked by 12 safety padlocks at the same time, convenient for administration. ●it has 6 hooks inside. 	200*162*90mm



EMERGENCY FIRE KEY BOX

Model	Description	size
EP-8813	<p>Material: Cold rolled steel Finish: Powder coating/ hot galvanizing Color: Red Lockable: Yes Pretreatment: Phosphorization ODM / OEM: Acceptable Emergency Key Box constructed from steel, with a break glass front panel. Ideal way to help ensure that access to the most important keys can be restricted to prevent anyone unauthorised from getting hold of them.</p> <p>Designed to hold a key for emergency use The vibrant red of the cases means they can be easily identified when the user is in a hurry</p>	200*80*60mm



METAL WALL LOCK BOX

Model	Description	size
EP-8814	<p>color: Red Cabinet Mounting Type: wall mounted maximum numbers of padlocks: 7 padlocks includes:7 key hooks</p>	178mm H*203mm W*57mm D



WALL MOUNT GROUP LOCK BOX

Model	Description
EP-8815	<ul style="list-style-type: none"> ● 430-grade stainless steel with heavy-duty powder coating withstands outdoor elements and provides corrosion resistance. Clear, impact-resistant window for viewing secured key(s) during lockout. ● Latch features lock hole designated for the control lock. ● 12 numbered lock holes for personal safety locks. ● Wall mounted for easy accessibility. ● Includes removable lock caddy for easy transportation of equipment locks to isolation points during lockout. ● Removable key cup to collect and maintain visibility of secured key(s) during lockout, and easy retrieval of key(s) after release of lockout. ● Pre-punched rivet holes offer option to attach a brass or aluminum laser-engraved tag. ● Replacement lock caddy and key cup available separately



PERMIT DISPLAY CASE

Model	Description
EP-8816	<ul style="list-style-type: none"> ● 430-grade stainless steel with heavy-duty powder coating withstands outdoor elements and provides corrosion resistance. ● Clear, impact-resistant window for viewing and protecting permit. ● documents Rubber seal protects documents from water damage in outdoor applications or during cleaning. ● Wall mounted for easy accessibility. ● Includes carrying handle for portability when not wall mounted.



Code	Description	Size(mm)	Dimensions
A	Width	308	
B	station height	787	
C	file box height	441	
D	file box thickness	57	
D	station height	348	
F	station thickness	119	



NAME	ITEM NO.	INCLUDING	
Personal Safety Electrical Lockout padlock Group Kit	EP- 8771A	Personal Electrical Lockout Pouch kit containing (1)one padlock tool waist pack (2)one lockout hasp(EP-8311) (3)Two miniature steel circuit breaker lockout(EP-D17) (4)One large steel circuit breaker lockout(EP-D18) (5)six padlock tagouts (6)one aluminium padlock(EP-8521A-KD)	
Personal Safety Lockout Pouch, Anodized Aluminum Padlocks	EP-8771B	personal safety lockout pouch containing: (1)one padlock tool waist pack (2)three aluminum padlocks(EP-8521A-KD) (3)one lockout hasp(EP-8311) (4)six padlock tagouts	
Personal Group Safety Lockout Kit	EP-8771C	personal group safety lockout pouch containing: (1)one padlock tool waist pack (2)Two aluminum padlocks(EP-8521A-KD) (3)one lockout hasp(EP-8311) (4)one lockout hasp(EP-8312) (5)six padlock tagouts	
Personal Safety Electrical Lockout Kit	EP-8771D	Personal Safety Electrical Lockout Kit cotaining. (1)One padlock tool waist pack (2)Two steel shackle safety padlock(EP-8521) (3)One lockout hasp(EP-8311) (4)One lockout hasp(EP-8316) (5)Six padlock tagouts (6)One minature circuit breaker lockout(EP-D04) (7)One medium clamp-on breaker lockout(480/600v) (EP-D12) (8)One large clamp-on breaker lockout(EP-D13)	
Personal Breaker Lockout Tool Bag Kit	EP-8772A	Personal Breaker Lockout Tool Bag Kit cotaining (1)One tool Handbag. (2)Three Steel shackle safety padlock(EP-8521) (3)One lockout hasp(EP-8311) (4)Two lockout hasp(EP-8316) (5)One medium clamp-on breaker lockout(480/600v)(EP-D12) (6)One large clamp-on breaker lockout(EP-D13) (7)Four universal cbs lockout, two(EP-D01), two(EP-D02) (8)Two easy useful mini cbs lockout(EP-D03) (9)Ten padlock tags.	

NAME	ITEM NO.	INCLUDING	
Personal Electrical Lockout bag Kit with Padlocks and cable lock	EP-8772B	Personal Electrical Lockout bag Kit containing (1)One tool Handbag. (2)Three Steel shackle safety padlock(EP-8521) (3)One lockout hasp(EP-8311) (4)Two lockout hasp(EP-8316) (5)Two mini clamp-on breaker lockout(120/227v)(EP-D11) (6)One large clamp-on breaker lockout(480/600v)(EP-D12) (6)Two easy useful mini cbs lockout(EP-D03) (7)One electrical plug lockout(EP-Q13) (8)One adjustable cable lockout(EP-L41) (9)Ten padlock tags	
Personal Breaker Lockout bag Kit with aluminum Padlock	EP-8772C	Personal Breaker Lockout Kit with Aluminum Padlocks containing: (1)One medium tool box. (2)Three aluminum padlocks(EP-8521A-KD) (3)One safety cable padlock(EP-8541) (4)Two new design steel breaker lockout(EP-D17) (5)Two steel breaker lockout(EP-D18) (6)One large aluminum lockout hasp.(EP-8322) (7)One universal wall's switch board lockout.(EP-D23) (8)Ten padlock tags	
Personal Breaker and valve Lockout bag with padlocks Kit	EP-8772D	Personal valve Lockout Padlock box Kit containing: (1)One medium tool box. (2)Three steel shackle keyed differ safety padlocks(EP-8521) (3)One large aluminum lockout hasp.(EP-8322) (4)One universal lockout hasp(EP-8311) (5)One cable lock(EP-L11) (6)One gate valve lock 127mm-165mm(5"-6.5")(EP-8233) (7)One seal tight handle-on ball valve lockout (8)Ten padlock tags	
Personal valve Lockout Padlock bag Kit	EP-8772E	Personal Breaker Lockout Box Kit with laminated padlock containing: (1)One medium tool box. (2)Three long shackle laminated padlock(EP-8521) (3)One lockout hasp(EP-8311) (4)Two lockout hasp(EP-8316) (5)Two medium clamp-on breaker lockout(480/600v)(EP-D12) (6)Two large clamp-on breaker lockout(EP-D13) (6)Two universal cbs lockout(EP-D04) (7)Ten padlock tags	
Personal Breaker Lockout Tool Box Kit	EP-8773A	Personal Breaker Lockout Tool Box Kit containing (1)One medium tool box. (2)Three Steel shackle safety padlock(EP-8521) (3)One lockout hasp(EP-8311) (4)Two lockout hasp(EP-8316) (5)One medium clamp-on breaker lockout(480/600v) (EP-D12) (6)One large clamp-on breaker lockout(EP-D13) (7)Four universal cbs lockout,two(EP-D01),two(EP-D02) (8)Two easy useful mini cbs lockout(EP-D03) (9)Ten padlock tags.	

NAME	ITEM NO.	INCLUDING	
Personal Electrical Lockout box Kit with Padlocks and cable lock	EP-8773B	Personal Electrical Lockout box Kit containing (1)One medium tool box. (2)Three Steel shackle safety padlock(EP-8521) (3)One lockout hasp(EP-8311) (4)Two lockout hasp(EP-8316) (5)Two mini clamp-on breaker lockout(120/227v)(EP-D11) (6)One large clamp-on breaker lockout(480/600v)(EP-D12) (7)Two easy useful mini cbs lockout(EP-D03) (8)One electrical plug lockout(EP-Q13) (9)One adjustable cable lockout(EP-L41) (10)Ten padlock tags	
Personal Breaker Lockout box Kit with aluminum Padlocks	EP-8773C	Personal Breaker Lockout Kit with Aluminum Padlocks containing: (1)One medium tool box. (2)Three aluminum padlocks(EP-8521A-KD) (3)One safety cable padlock(EP-8541) (4)Two new design steel breaker lockout(EP-D17) (5)Two steel breaker lockout(EP-D18) (6)One large aluminum lockout hasp.(EP-8322) (7)One universal wall's switch board lockout.(EP-D23) (8)Ten padlock tags	
Personal Breaker and valve Lockout box Kit	EP-8773D	Personal Breaker and valve Lockout bag Kit containing: (1)One medium tool box. (2)Three steel shackle keyed differ safety padlocks(EP-8521) (3)One safety cable padlock(EP-8541) (4)One cable lock(EP-L11) (5)Two new design steel breaker lockout(EP-D17) (6)Two single and multi-pole configurations steel breaker lockout(EP-D18) (7)One large aluminum lockout hasp(EP-8322) (8)One universal lockout hasp(EP-8311) (9)One universal wall's switch board lockout(EP-D23) (10)One gate valve lock 127mm-165mm(5"-6.5")(EP-8233) (11)Ten padlock tags	
Personal valve Lockout Padlock box Kit	EP- 8773E	Personal valve Lockout Padlock bag Kit containing: (1)One tool Handbag. (2)Three steel shackle keyed differ safety padlocks(EP-8521) (3)One large aluminum lockout hasp.(EP-8322) (4)One universal lockout hasp(EP-8311) (5)One cable lock(EP-L11) (6)One gate valve lock 127mm-165mm(5"-6.5")(EP-8233) (7)One seal tight handle-on ball valve lockout (8)Ten padlock tags	
Personal Breaker Lockout Box Kit with laminated padlock	EP-8773F	Personal Breaker Lockout Box Kit with laminated padlock containing: (1)One tool Handbag. (2)Three long shackle laminated padlock(EP-8521) (3)One lockout hasp(EP-8311) (4)Two lockout hasp(EP-8316) (5)Two medium clamp-on breaker lockout(480/600v)(EP-D12) (6)Two large clamp-on breaker lockout(EP-D13) (7)Two universal cbs lockout(EP-D04) (8)Ten padlock tags	

4 PADLOCK STATION

Discription: 4pcs padlocks, 3 hasps and 12 tagouts are in lockout station.extra-thick Acrylic,patent hook. Made of high-quality organic glass, excellent aging risistance and color , good insulativity.

ITEM NO.	SIZE	REMARKS
EP-S41	23cm*33cm*0.5cm	Station Only
EP-S42	23cm*33cm*0.5cm	With accessories



10 PADLOCK STATION

Discription: 10pcs padlocks, 3 hasps and 12 tagouts are in lockout station.extra-thick Acrylic,patent hook. Made of high-quality organic glass, excellent aging risistance and color , good insulativity.

ITEM NO.	SIZE	REMARKS
EP-S51	32cm*49cm*0.5cm	Station Only
EP-S52	32cm*49cm*0.5cm	With accessories

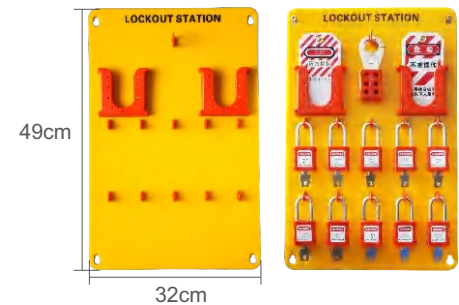

20 PADLOCK STATION

Discription:20pcs padlocks, 6hasps and 24 tagouts are in lockout station.extra-thick Acrylic,patent hook. Made of high-quality organic glass, excellent aging risistance and color , good insulativity.

ITEM NO.	SIZE	REMARKS
EP-S61	53.6cm*49cm*0.5cm	Station Only
EP-S62	53.6cm*49cm*0.5cm	With accessories

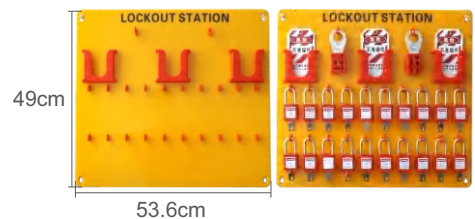

36 PADLOCK STATION

Discription:36pcs padlocks, 9hasps and 36 tagouts are in lockout station.extra-thick Acrylic,patent hook. Made of high-quality organic glass, excellent aging risistance and color , good insulativity.

ITEM NO.	SIZE	REMARKS
EP-S71	63.8cm*62.5cm*0.5cm	Station Only
EP-S72	63.8cm*62.5cm*0.5cm	With accessories

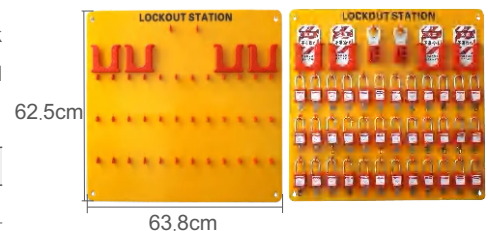

TAGOUT CENTER

Description: For central manager and tell all kinds of tagouts. There are 10 tagout positions.

- It's made of acrylic board with ABS Material box, well-marked.
- The tag box can be taken down and cleaned. The Warnings is silk screen ,very durable

ITEM NO.	SIZE	REMARKS
EP-S81	53.6cm *49cm *0.5cm	Station Only



METAL LOCK CABINET

Metal lockout cabinet make lockout more easy to mange and adjust space for different size lockout.

Advantage:

- Made of carbon steel, barking varnish finised, yellow or customised according to custmer
- Built-in slots, adjust slots based on size of lockout, make most use of space.
- Two seperator for each cabnet, provide pay seperator.
- can mouted on wall and take it everywhere you want

Item No.	Size	REMARKS
EP-S91	320mm x 60mm x 400mm	Station only



4 LOCK STATION WITH DOOR

Description: Upscale Visible lock station for managing all kinds of safety lockouts

Name: Lock Station of 4 locks (with locks)

Features:

- Steel Material with yellow baking finish, clear acrylic window
- With 4 padlocks 3 hasps and 12 tagouts inside
- Visible window , dust prood and you can see everything inside

Item No.	Size	REMARKS
EP-S41A	260*100*350mm	Wall-mounted, station only
EP-S42A	260*100*350mm	Wall-mounted, with parts



10 LOCK STATION WITH DOOR

Description: Upscale Visible lock station for managing all kinds of safety lockouts

Features:

- Steel Material with yellow baking finish, clear acrylic window
- With 10 padlocks, 6 hasps and 12 tagouts inside
- Visible window, dust proof and you can see everything inside

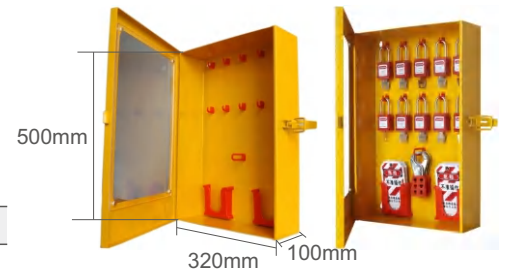

Item No.	Size	REMARKS
EP-S51A	320*100*500mm	Wall-mounted, station only
EP-S52A	320*100*500mm	Wall-mounted, with parts

20 PADLOCKS STATION WITH DOOR

Visual dust-proof padlock station with door in yellow is easy to manage different kind of lockout. plastic hook easy to change and maintain

Advantage:

- barking varnished heavy steel, High t ransparent Acrylic
- 20pcs padlocks, 6pcs hasps, 24pcs tagouts
- Size: 480*100*580mm

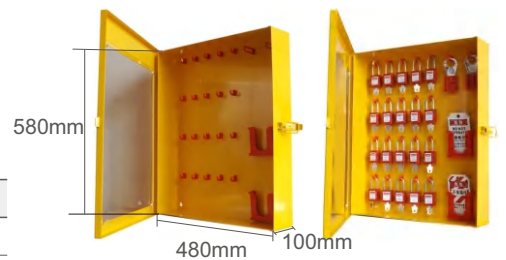

Item No.	Size	REMARKS
EP-S61A	480*100*580mm	Wall-mounted, station only
EP-S62A	480*100*580mm	Wall-mounted, with parts

COMBINATION LOCKOUT STATION

- Be made of strong impact resistance steel plate, baking varnish performance, usual
- usual yellow color, can be customized according to customer needs in different colors. The
- the unique design of the inner wall card slot, can adjust the clapboard position according to the requirements.
- To store different locks. Standard two clapboards, can provide clapboard separately as requests.
- Available with both wall mounted and portable.

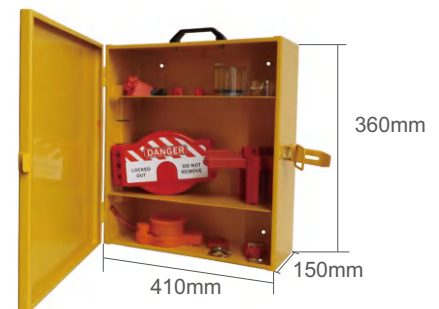

Item No.	Size	REMARKS
EP-S21	410mm*360mm*150mm	Station only

COMBINATION LOCK STATION

Description: Combination metal Lock Station, can be available for 12 padlocks and other big lockouts

Features:

- High quality clear Organosheet with yellow baking finish fashion style.
- The special ABS hook on the board, very durable and avoiding the friction with metal shackle . It will protect the lockouts.
- The diameter of lock hole is 8mm.Also can be use with hasp, so that many people can use it at same time.

Item No.	Size	REMARKS
EP-S22	560*360*150mm	Station only



LOCKOUT MANAGEMENT STATION

- Made from surface high temperature spraying plastics treatment steel plate.
- With two mobile division plate, can set the division space flexibly.
- Fix it by screw.
- Can be customized made non-perspective panel.

Part Code	Description
EP-X07	Width × height × thickness: 360×450×155mm



KEY BOX

Discription:two type of key box: portable and wall-mounted.three model to choose, easy to store and manage keys **Material:** carbon steel

Advantage:



- Easy to identify by writing number
- Easy to manage by writing user name.
- Magnetic lock, two keys , can be mouted on wall or put on floor.

Item No.	Size	REMARKS
EP-S23	25*20*8CM	can store 32 keys



COMBINATION LOCKOUT STATION

- Made from engineering plastic PC, combined design, strong and durable.
- Station can be locked, Lock hole diameter 10mm
- Large storage space, suitable for storing all kinds of large locks
- Can be installed handle, practical and portable
- The transparent door is designed with a handle for easy opening / closing

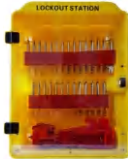
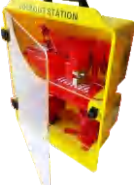
ITEM NO.	Description	Capacity	
EP-SL1	340(Length)*160(Width)*415mm(height)	Can accommodate 6 padlocks, 12 tags, 6 hasps and, several lockouts etc.	
EP-SL2	340(Length)*160(Width)*415mm(height)	Can accommodate 11 padlocks and several lockouts etc.	
EP-SL3	340(Length)*160(Width)*415mm(height)	Can accommodate 15 padlocks, 12 tags, 6 hasps and several lockouts etc.	
EP-SL4	340(Length)*160(Width)*415mm(height)	Can accommodate 28 padlocks and several lockouts etc.	
EP-SL5	340(Length)*160(Width)*415mm(height)	Layered storage, various types of large locks, portable	

MOBILE STORAGE STATION

Material: Acrylic

Description: Used when you need to store personal mobile phones, such as conferences, indoor storage, display, etc.

Features:

- Exquisite transparent, high-grade appearance
- The standard 8-position, overall dimensions: 40CM * 48CM, can also be customized workers digits
- Each station independently locks, independent key, label
- Each station length 20CM, can be stored for the vast majority of phones on the market

Item No.	Size	REMARKS
EP-S82	40CM*48CM	

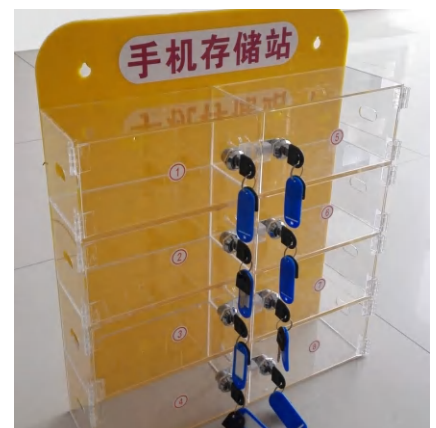

COMBINED LOCKOUT STATION

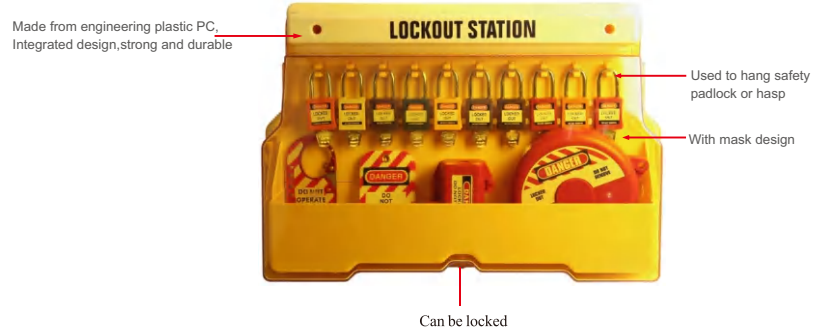
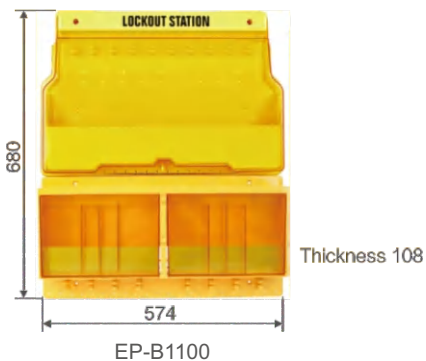
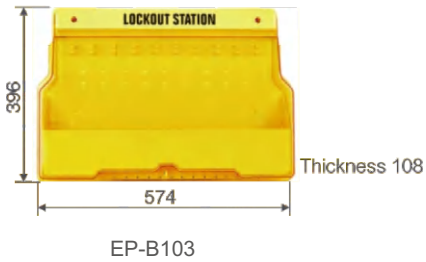
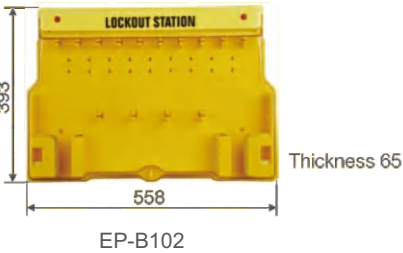
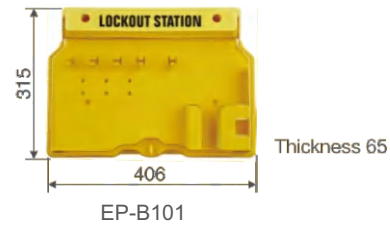

Model	Description
EP-B101	With 4 padlock positions, each position can accommodate 2 padlocks; 1 hasp, several tagouts, cable ties, etc.
EP-B102	With 10 padlock positions, each position can accommodate 2 padlocks; 4 hasp, several tagouts, cable ties, etc.
EP-B103	With 8 padlock positions, each position can accommodate 2 padlocks; Beside can accommodate various of padlocks, several tagouts, cable ties, etc.
EP-B104	With 8 padlock positions, each position can accommodate 2 padlocks; Beside can accommodate various of padlocks, several tagouts, cable ties, etc.
EP-B105	With 4 padlock positions, each position can accommodate 2 padlocks; Beside can accommodate various of padlocks, several tagouts, cable ties, etc.
EP-B1100	With 8 padlock positions, each position can accommodate 2 padlocks; Beside can accommodate various of padlocks, several tagouts, cable ties, etc. <i>(This model is EP-B103 and EP-B104's combination lockout station)</i>

COMBINATION ADVANCED LOCKOUT STATION

- Made form engineering plastic PC, combined design, strong and durable.
- Station can be locked.
- With mask design.

ITEM NO.	Description	Capacity	
EP-B201	Width×Height×Thickness 605×580×95mm	With 4 padlock positions, each position can accommodate 2 padlocks; 1 hasp, several tagouts, cable ties, etc.	
EP-B202	Width×Height×Thickness 605×580×95mm	With 10 padlock positions, each position can accommodate 2 padlocks; 4 hasps, several tagouts, cable ties, etc.	
EP-B203	Width×Height×Thickness 605×580×95mm	Can accommodate 10 padlocks, 2 mobile phone boxes, 6 hasps, several t agouts ,cable tie and mini Lockouts etc.	
EP-B204	Width×Height×Thickness 605×580×95mm	Can accommodate 10 padlocks,3 mobile phone boxes, 3 hasps, several tagouts , cable tie and mini Lockouts etc.	
EP-B205	Width×Height×Thickness 605×580×95mm	Can accommodate 12 padlocks,2 mobile phone boxes, several hasps, tagouts cable ties and mini Lockouts etc.	

COMBINATION ADVANCED LOCKOUT STATION

- Made form engineering plastic PC, combined design, strong and durable.
- Station can be locked.
- With mask design.

ITEM NO.	Description	Capacity	
EP-B206	Width×Height×Thickness 605×580×95mm	Can accommodate 10 padlocks,2 A4 size written board(can clip working tickets), several hasps,tagouts, cable ties and mini lockouts etc.	
EP-B206W	Width×Height×Thickness 605×580×95mm "W" means the station without mask	Can accommodate 10 padlocks,2 A4 size written board(can clip working tickets), several hasps,tagouts, cable ties and mini lockouts etc.	
EP-B207	Width×Height×Thickness 650×590×95mm	Can accommodate 2 A4 size written board (can clip working tickets),several hasps, tagouts, cable ties and mini lockouts etc.	
EP-B207W	Width×Height×Thickness 605×580×95mm "W" means the station without mask	Can accommodate 2 A4 size written board (can clip working tickets),several hasps, tagouts, cable ties and mini lockouts etc.	
EP-B208	Width×Height×Thickness 605×580×95mm	Can accommodate 2 A4 size written board (can clip working tickets),2 mobile phones boxes, several padlocks, hasps,tagouts, cable ties and mini lockouts etc.	
EP-B208W	Width×Height×Thickness 605×580×95mm "W" means the station without mask	Can accommodate 2 A4 size written board (can clip working tickets),2 mobile phones boxes, several padlocks, hasps,tagouts, cable ties and mini lockouts etc.	
EP-B209	Width×Height×Thickness 605×580×95mm	Can accommodate 6 mobile phones boxes.	
EP-B210	Width×Height×Thickness 605×580×95mm	Can accommodate 10 padlocks,1A4 size written board(can clip working tickets), 2 mobile phones boxes, several tagouts, cable ties and mini lockout etc.	
EP-B210W	Width×Height×Thickness 605×580×95mm "W" means the station without mask	Can accommodate 10 padlocks,1A4 size written board(can clip working tickets), 2 mobile phones boxes, several tagouts, cable ties and mini lockout etc.	

LOCKOUT KIT

Model	Capacity	
EP-9771A	<p>Kit including:</p> <ul style="list-style-type: none"> 1pcs 38mm steel shackle padlock EP-8521 1pcs MCB lockout EP-D01 1pcs MCB lockout EP-D001 1pcs PVC tags EP-8611 	
EP-9771B	<p>Kit including:</p> <ul style="list-style-type: none"> 1pcs 38mm steel shackle padlock EP-8521 1pcs steel Hasp Lockout EP-8311 1pcs MCB lockout EP-D2394 1pcs MCB lockout EP-D11 1pcs MCB lockout EP-D01 1pcs MCB lockout EP-D001 3pcs PVC tags EP-8611 	
EP-9771C	<p>Kit including:</p> <ul style="list-style-type: none"> 10pcs PVC tags EP-8611 1pcs MCB lockout EP-D11 1pcs MCB lockout EP-D01 1pcs MCB lockout EP-D01 1pcs hasp lockout 1" EP-8311 1pcs mark pen 	<ul style="list-style-type: none"> 2pcs 38mm steel padlock 1pcs MCB lockout EP-D12 1pcs MCB lockout EP-D01 1pcs MCB lockout EP-D001 1pcs insulation hasp EP-8313
EP-9772A	<p>Kit including:</p> <ul style="list-style-type: none"> 10pcs PVC tags EP-8611 3pcs 38mm steel shackle padlock EP-8521 2pcs MCB lockout (EP-D11) 2pcs MCB lockout (EP-D12) 1pcs MCB lockout (EP-D13) 3PCS Steel hasp lockout 1"(EP-8311) 2pcs MCB lockout (EP-D03) 	
EP-9773A	<p>Kit including:</p> <ul style="list-style-type: none"> 1pcs 38mm insulation shackle padlock EP-8531 1pcs 38mm steel shackle padlock EP-8521 1pcs MCB lockout EP-D2394 1pcs MCB lockout EP-D01 1pcs MCB lockout EP-D02 1pcs MCB lockout EP-D04 1pcs MCB lockout EP-D091 	<ul style="list-style-type: none"> 1pcs insulation Hasp EP-8313B EP-D11 1pcs MCB lockout EP-D05-2 1pcs MCB lockout EP-D03 1pcs MCB lockout EP-D001 4pcs PVC tags EP-8611
EP-9773B	<p>Kit including:</p> <ul style="list-style-type: none"> 4pcs nylon padlock (EP-8531) 1PCS HASP LOCKOUT 1.5" 1pcsgate valve lockout EP-8231 1pcs mcb lockout EP-D14N 10pcs PVC tags EP-8611 	<ul style="list-style-type: none"> 1PCS HASP LOCKOUT 1" 1pcs cable lockout EP-L11 1pcs steel hasp EP-8311 1pcs mcb lockout EP-D04
EP-9772C	<p>Kit including:</p> <ul style="list-style-type: none"> 3pcs 38mm padlock (EP-8521) 1pcs valve lockout EP-8210 1pcs plug lockout EP-D41 1pcs UNIVERSAL WALL SWITCH BOARD EP-D23 1pcs adjustable valve EP-8241 10pcs PVC tags EP-8611 	<ul style="list-style-type: none"> 2pcs nylon hasp lockout (EP-8313B) 2pcs cable lockout EP-L71 1pcs SOCKET LOCKOUT EP-D46

LOCKOUT TAGS

Lockout tagout tags are OSHA compliant and communicate safety and lockout information at the point of need. These tags come in a variety of materials to suit your specific lockout/tagout (LOTO) needs. You can also create your own custom tag for an application specific message

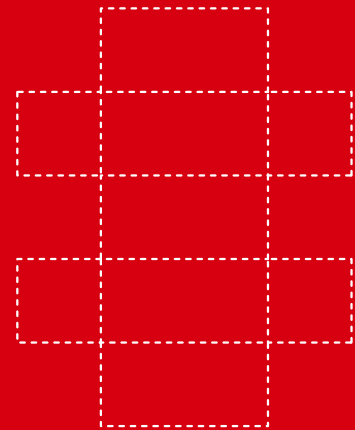

LOCKOUT TAGOUT

Product Introduction

- Lockout tagout can be used to make a holistic control of the equipment to protect workers from accident and equipment from damage.
- Use with padlock to remind that the device has been locked and can not be operated. It can only be opened by the one who lock it. It enables people to know who lock it and so that they know it is danger to operate the device.
- On the tag, you can see "Danger/Do not operate/caution" etc security warning language and also "Name/department/Date" etc blank for you to fill in.
- Offer language customization.

Product Selection

<p>Display</p>		
<p>Model</p>	<p>EP-8611A</p>	<p>EP-8611B</p>
<p>Size</p>	<p>145X135mm</p>	<p>147X76mm</p>
<p>Material</p>	<p>PVC with plastic covered</p>	<p>PVC</p>
<p>Display</p>		
<p>Model</p>	<p>EP-8611C</p>	<p>EP-8611D</p>
<p>Size</p>	<p>145X75mm</p>	<p>145X75mm</p>
<p>Material</p>	<p>PVC</p>	<p>PVC</p>

<p>Display</p>		
<p>Model</p>	<p>EP-8611E</p>	<p>EP-8611F</p>
<p>Size</p>	<p>140X80mm</p>	<p>140X80mm</p>
<p>Material</p>	<p>PVC</p>	<p>PET</p>



SCAFFOLDING TAG

EP-P31 SMALL MULTIFUNCTIONAL SCAFFOLDING TAG

Scaffolding Holder	Tag	Customization
Unit:mm 		

EP-P32 MULTIFUNCTIONAL SCAFFOLDING TAG

Thickness: 6mm
Weight:30g

Scaffolding Holder	Tag	Customization
Unit:mm 		

EP-P33 CIRCULAR TYPE MULTIFUNCTIONAL SCAFFOLDING TAG

Thickness: 6mm
Weight:75g

Scaffolding Holder	Tag	Customization
Unit:mm 		

EP-P34 LARGE MULTIFUNCTIONAL SCAFFOLDING TAG

Thickness: 6mm
Weight: 88g

Scaffolding Holder	Tag	Customization
<p>Unit:mm</p>		

EP-P35 HOOK TYPE MULTIFUNCTIONAL SCAFFOLDING TAG

Thickness: 6mm
Weight: 88g

Scaffolding Holder	Tag	Customization
<p>Unit:mm</p>		

EP-P36 MULTIFUNCTIONAL SCAFFOLDING TAG

Thickness: 6mm
Weight: 110g

Scaffolding Holder	Tag	Customization
<p>Unit:mm</p>		

EP-P37 MULTIFUNCTIONAL SCAFFOLDING TAG

Thickness: 6.5mm

Scaffolding Holder	Tag	Customization
<p>Unit:mm</p>		

EP-P38

CIRCULAR TYPE MULTIFUNCTIONAL SCAFFOLDING TAG

Thickness: 6.7mm
Weight: 62.2g



EP-P39

CIRCULAR TYPE MULTIFUNCTIONAL SCAFFOLDING TAG

Thickness: 6mm

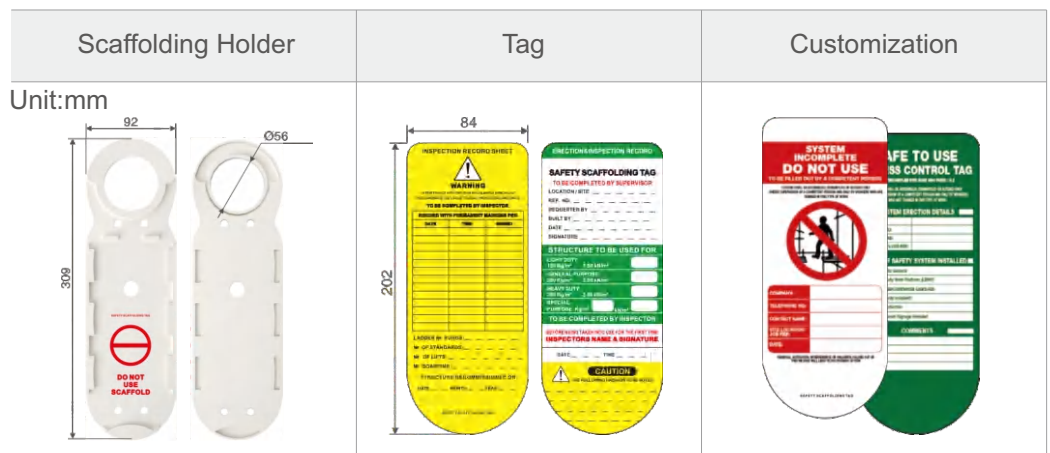

EP-P40

MULTIFUNCTIONAL SCAFFOLDING TAG

Thickness: 7mm

